



# Kilökök

5.1

# Auswerferstifte

# 5.1

**Kilőkök**

**Auswerferstifte**

**Ejector pins**



**BÜTTNER Normália Kft.**

7500 Nagyatád, Taranyi út, Ipartelep

Tel: +36-82-553-970 / +36-82-553-971

Fax: +36-82-553-981 / +36-82-553-982

E-mail: [vranicsf@buttner.hu](mailto:vranicsf@buttner.hu), [buttner@hu.inter.net](mailto:buttner@hu.inter.net)

[www.buttner.hu](http://www.buttner.hu)

## TARTALOMJEGYZÉK / INHALTSVERZEICHNIS / TABLE OF CONTENTS

Hengeres fejű kilökő, edzett / Auswerferstift, gehärtet / Ejector pin, hardened / KIHA	1
Hengeres fejű kilökő, nitridált, eloxált / Auswerferstift, nitriert, oxidiert / Ejector pin, nitrided and oxidized / KIHO	4
Hengeres fejű kilökő, nitridált / Auswerferstift, nitriert, blank / Ejector pin, nitrided / KIHN	8
Magformázó kilökő / Kernstift, gehärtet, unnitriert / Core pin, hardened, non-nitrided / KIMF	12
Kúpos fejű kilökő, edzett / Auswerferstift, gehärtet / Ejector pin, hardened / KIKA	16
Erősített szárú kilökő, edzett / Auswerferstift, abgesetzt, gehärtet / Ejector pin, stepped, hardened / KIEA	20
Erősített szárú kilökő, nitridált, eloxált / Auswerferstift, abgesetzt, nitriert, oxidiert / Ejector pin, stepped, nitrided and oxidized / KIEO	21
Erősített szárú kilökő, nitridált / Auswerferstift, abgesetzt, nitriert / Ejector pin, stepped, nitrided / KIEN	22
Laposkilökő, edzett / Flachauswerfer, gehärtet / Flat ejector pin, hardened / KILA	23
Laposkilökő, edzett, rádiusszal R 0,3 / Flachauswerfer, gehärtet mit Radius R 0,3 / Flat ejector pin, hardened with radius R 0,3 / KILA-R	24
Laposkilökő, nitridált, eloxált / Flachauswerfer, nitriert, oxidiert / Flat ejector pin, nitrided and oxidized / KILN	25
Laposkilökő, nitridált / Flachauswerfer, nitriert / Flat ejector pin, nitrided / KILN	26
Csőkilökő, edzett / Auswerferhülse, gehärtet / Ejector sleeve, hardened / KICA	27
Csőkilökő, nitridált, eloxált / Auswerferhülse, nitriert, oxidiert / Ejector sleeve, nitrided and oxidized / KICN	29

## KIHA

**Hengeres fejű kilökö, edzett**  
**Auswerferstift, gehärtet**  
**Ejector pin, hardened**  
**DIN ISO 6751 (DIN 1530-1)**

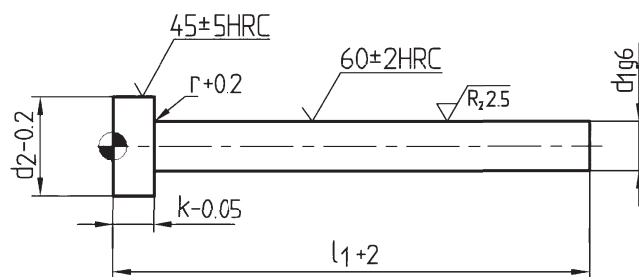

Rendelési példa: }  
 Bestell-Beispiel: } **KIHA-d1xl<sub>1</sub>**  
 Order example: }

Anyag: }  
 Werkstoff: } **1.2516**  
 Material: }

k	r	d <sub>2</sub>	d <sub>1</sub>	l <sub>1</sub>	€
1,2	0,2	2,5	0,8	40	2,67
				63	3,33
				80	3,33
				100	3,47
				125	3,60
				160	3,73
				200	4,00
1,2	0,2	2,5	1	40	2,80
				63	3,07
				80	3,07
				100	3,07
				125	3,33
				160	3,60
				200	3,73
1,2	0,2	2,5	1,1	40	2,80
				63	3,07
				80	3,07
				100	3,07
				125	3,33
				160	3,60
				200	3,73
1,2	0,2	2,5	1,2	40	2,80
				63	3,07
				80	3,07
				100	3,07
				125	3,33
				160	3,60
				200	3,73
1,5	0,2	3	1,3	40	2,80
				63	3,07
				80	3,07
				100	3,07
				125	3,33
				160	3,60
				200	3,73
1,5	0,2	3	1,4	40	2,80
				63	3,07
				80	3,07
				100	3,07
				125	3,33
				160	3,60
				200	3,73
1,5	0,2	3	1,5	40	1,55
				63	1,59
				80	1,62
				100	1,65
				125	1,93
				160	2,13
				200	2,66
1,5	0,2	3	1,6	40	1,55
				63	1,59

k	r	d <sub>2</sub>	d <sub>1</sub>	l <sub>1</sub>	€
1,5	0,2	3	1,6	80	1,62
				100	1,65
				125	1,93
				160	2,13
				200	2,66
				200	2,66
1,5	0,2	3	1,7	40	2,22
				63	2,31
				80	2,42
				100	2,43
				125	3,23
				160	3,55
1,5	0,2	3	1,8	40	2,22
				63	2,31
				80	2,42
				100	2,43
				125	3,23
				160	3,55
1,5	0,2	3	1,9	40	1,44
				63	1,52
				80	1,60
				100	1,68
				125	1,92
				160	2,12
2	0,2	4	2	40	1,21
				63	1,29
				80	1,37
				100	1,45
				125	1,63
				160	1,92
2	0,2	4	2,2	100	1,54
				200	2,48
				315	3,50
				315	3,50
				315	3,50
				315	3,50
2	0,3	5	2,5	40	1,21
				63	1,29
				80	1,37
				100	1,45
				125	1,63
				160	1,92
2	0,3	5	2,7	100	1,55
				200	2,43
				315	3,43
				315	3,43
				315	3,43
				315	3,43

## KIHA

Hengeres fejű kilökő, edzett  
 Auswerferstift, gehärtet  
 Ejector pin, hardened  
 DIN ISO 6751 (DIN 1530-1)

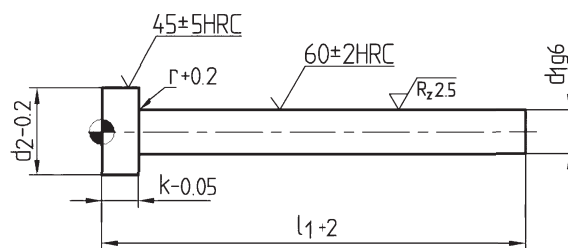

Rendelési példa: }  
 Bestell-Beispiel: } **KIHA-d1xl<sub>1</sub>**  
 Order example: }

Anyag: }  
 Werkstoff: } **1.2516**  
 Material: }

k	r	d <sub>2</sub>	d <sub>1</sub>	l <sub>1</sub>	€
3	0,3	6	3	40	1,20
				63	1,28
				80	1,35
				100	1,43
				125	1,62
				160	1,88
				200	2,29
				250	2,72
				315	3,05
3	0,3	6	3,2	100	1,58
				200	2,53
				400	4,17
				3	0,3
63	1,46				
80	1,46				
100	1,54				
125	1,70				
160	1,98				
200	2,48				
250	3,37				
315	3,80				
400	4,17				
3	0,3	7	3,7	100	1,58
				200	2,53
				400	4,17
3	0,3	8	4	40	1,27
				63	1,36
				80	1,43
				100	1,51
				125	1,68
				160	1,96
				200	2,45
				250	2,74
				315	3,13
400	3,91				
3	0,3	8	4,2	100	1,70
				200	2,66
				400	4,56
3	0,3	8	4,5	63	1,66
				80	1,66
				100	1,66
				125	1,94
				160	2,16
				200	2,61
				250	3,57
				315	4,34
				400	4,56
3	0,3	8	4,7	100	1,66
				200	2,61
				400	4,56

k	r	d <sub>2</sub>	d <sub>1</sub>	l <sub>1</sub>	€			
3	0,3	10	5	40	1,43			
				63	1,47			
				80	1,59			
				100	1,64			
				125	1,92			
				160	2,15			
				200	2,60			
				250	3,15			
				315	3,52			
3	0,3	10	5,2	100	1,96			
				200	3,01			
				400	5,60			
				3	0,3	10	5,5	100
125	2,16							
160	2,52							
200	3,01							
250	4,04							
315	4,64							
400	5,60							
5	0,5	12	6	40				1,61
				63				1,64
				80	1,84			
				100	1,94			
				125	2,15			
5	0,5	12	6,2	160	2,50			
				200	2,99			
				250	3,52			
				315	3,99			
5	0,5	12	6,5	400	5,00			
				100	2,19			
				200	4,02			
				400	6,77			
5	0,5	12	6,5	63	2,04			
				80	2,04			
				100	2,04			
				125	2,68			
				160	3,17			
5	0,5	12	7	200	4,02			
				250	5,03			
				315	5,55			
				400	6,77			
				100	2,21			
				125	2,72			
				160	3,21			
				200	4,06			
				250	5,08			
315	5,60							
400	6,77							

## KIHA

Hengeres fejű kilökő, edzett  
 Auswerferstift, gehärtet  
 Ejector pin, hardened  
 DIN ISO 6751 (DIN 1530-1)

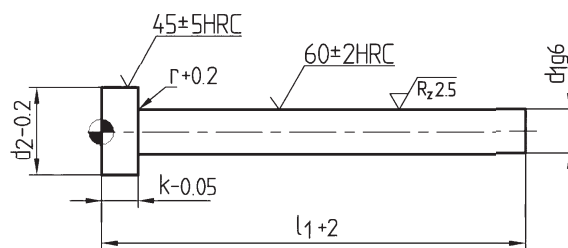

Rendelési példa: }  
 Bestell-Beispiel: } **KIHA-d1xl<sub>1</sub>**  
 Order example: }

Anyag: }  
 Werkstoff: } **1.2516**  
 Material: }

k	r	d <sub>2</sub>	d <sub>1</sub>	l <sub>1</sub>	€
5	0,5	14	8	63	1,84
				80	2,04
				100	2,15
				125	2,59
				160	3,12
				200	3,95
5	0,5	14	8,2	100	3,11
				200	5,40
				400	8,60
				5	0,5
125	3,74				
160	4,24				
200	5,43				
250	6,62				
315	7,68				
400	8,60				
5	0,5	14	9	80	3,01
				100	3,17
				125	3,74
				160	4,24
				200	5,43
				250	6,62
315	7,68				
400	8,60				
5	0,5	16	10	100	3,06
				125	3,61
				160	4,19
				200	5,39
				250	5,86
				315	6,51
400	8,34				
5	0,5	16	10,2	100	3,90
				200	6,87
				400	12,76
5	0,5	16	10,5	100	3,95
				125	4,68
				160	5,52
				200	7,01
				250	7,95
				315	9,77
400	12,76				
5	0,5	16	11	100	4,65
				125	5,52
				160	6,82
				200	7,73
				250	9,38
				315	11,20
400	14,59				
7	0,8	18	12	80	3,61
				100	3,86
				125	4,61

k	r	d <sub>2</sub>	d <sub>1</sub>	l <sub>1</sub>	€
7	0,8	18	12	160	5,42
				200	6,85
				250	8,18
				315	9,48
				400	13,03
7	0,8	18	12,2	100	4,91
				125	5,80
				160	6,82
				200	7,73
				250	9,61
				315	11,33
400	15,11				
7	0,8	18	12,5	100	4,39
				125	5,30
				160	6,31
				200	7,75
				250	9,63
				315	11,32
400	15,11				
7	0,8	22	14	100	4,80
				125	5,87
				160	7,12
				200	8,60
				250	11,01
				315	11,98
400	16,54				
7	0,8	22	16	100	6,35
				125	7,31
				160	8,48
				200	10,61
				250	13,16
				315	14,72
400	18,76				
7	1	24	18	100	11,55
				125	12,87
				160	13,98
				200	17,23
				250	22,53
315	27,22				
400	36,21				
8	1	26	20	100	9,29
				125	10,43
				160	11,60
				200	15,30
				250	19,54
315	25,53				
400	34,39				
10	1	32	25	100	14,99
				125	16,19
				160	17,34
				200	19,80
				250	22,29
315	28,13				
400	47,10				

## KIHO

Hengeres fejű kilökö, nitridált, eloxált  
 Auswerferstift, nitriert, oxidiert  
 Ejector pin, nitrided and oxidized  
 DIN ISO 6751 (DIN 1530-1)

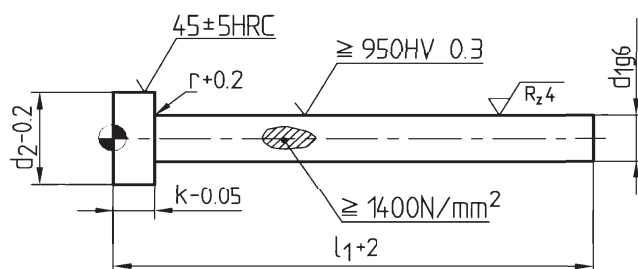

Rendelési példa: }  
 Bestell-Beispiel: } **KIHO-d1xl<sub>1</sub>**  
 Order example: }

Anyag: }  
 Werkstoff: } **1.2343**  
 Material: }

k	r	d <sub>2</sub>	d <sub>1</sub>	l <sub>1</sub>	€
1,2	0,2	2,5	1	40	3,17
				63	3,17
				80	3,17
				100	3,17
				125	3,33
				160	3,75
				200	5,00
1,2	0,2	2,5	1,1	40	3,33
				63	3,33
				80	3,33
				100	3,33
				125	3,75
				160	4,17
				200	5,17
1,2	0,2	2,5	1,2	40	3,33
				63	3,33
				80	3,33
				100	3,33
				125	3,75
				160	4,17
				200	5,17
1,5	0,2	3	1,3	40	3,33
				63	3,33
				80	3,33
				100	3,33
				125	3,75
				160	4,17
				200	5,17
1,5	0,2	3	1,4	40	3,33
				63	3,33
				80	3,33
				100	3,33
				125	3,75
				160	4,17
				200	5,17
1,5	0,2	3	1,5	40	3,06
				63	3,06
				80	3,06
				100	3,06
				125	3,33
				160	3,48
				200	3,82
1,5	0,2	3	1,6	40	2,25
				63	2,25
				80	2,25
				100	2,25
				125	2,67
				160	2,92
				200	3,83

k	r	d <sub>2</sub>	d <sub>1</sub>	l <sub>1</sub>	€
1,5	0,2	3	1,7	40	2,25
				63	2,25
				80	2,25
				100	2,25
				125	2,67
				160	2,92
				200	3,83
1,5	0,2	3	1,8	40	2,25
				63	2,25
				80	2,25
				100	2,25
				125	2,67
				160	2,92
				200	3,83
1,5	0,2	3	1,9	40	2,25
				63	2,25
				80	2,25
				100	2,25
				125	2,67
				160	2,92
				200	3,83
2	0,2	4	2	40	2,17
				63	2,17
				80	2,17
				100	2,17
				125	2,30
				160	2,41
				200	2,64
2	0,2	4	2,2	250	2,86
				315	3,55
				100	2,33
				200	2,85
2	0,2	4	2,2	315	3,55
				100	2,33
				200	2,85
				315	3,55
2	0,3	5	2,5	40	2,47
				63	2,47
				80	2,47
				100	2,47
				125	2,61
				160	2,72
				200	3,05
2	0,3	5	2,7	250	3,08
				315	3,55
				100	2,48
				200	3,06
				315	4,08
				100	2,48
				200	3,06

## KIHO

Hengeres fejű kilőkő, nitridált, eloxált  
 Auswerferstift, nitriert, oxidiert  
 Ejector pin, nitrided and oxidized  
 DIN ISO 6751 (DIN 1530-1)

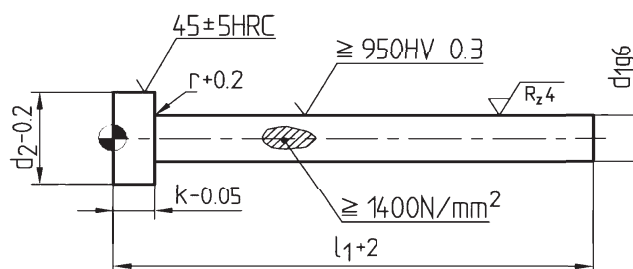

Rendelési példa: }  
 Bestell-Beispiel: } **KIHO-d1xl<sub>1</sub>**  
 Order example: }

Anyag: }  
 Werkstoff: } **1.2343**  
 Material: }

k	r	d <sub>2</sub>	d <sub>1</sub>	l <sub>1</sub>	€
3	0,3	6	3	40	1,99
				63	1,99
				80	1,99
				100	1,99
				125	2,07
				160	2,18
				200	2,42
				250	2,71
				315	2,97
				400	3,73
3	0,3	6	3,2	100	2,52
				200	3,15
				400	4,14
				500	4,53
				630	
				800	
3	0,3	7	3,5	40	2,61
				63	2,61
				80	2,61
				100	2,61
				125	2,82
				160	2,99
				200	3,29
				250	3,55
				315	4,01
				400	4,33
3	0,3	7	3,7	100	2,84
				200	3,36
				400	5,75
				500	7,67
				630	
				800	
3	0,3	8	4	40	2,10
				63	2,10
				80	2,10
				100	2,10
				125	2,20
				160	2,26
				200	2,52
				250	2,70
				315	3,06
				400	3,87
3	0,3	8	4,2	100	2,66
				200	3,37

k	r	d <sub>2</sub>	d <sub>1</sub>	l <sub>1</sub>	€
3	0,3	8	4,2	400	5,24
				500	8,13
				630	8,96
				800	
3	0,3	8	4,5	40	2,83
				63	2,83
				80	2,83
				100	2,83
				125	3,02
				160	3,08
				200	3,46
				250	3,76
				315	4,45
				400	5,53
3	0,3	8	4,7	100	1,92
				200	2,83
				400	6,00
				500	7,58
				630	10,42
				800	17,92
3	0,3	10	5	40	2,25
				63	2,25
				80	2,25
				100	2,25
				125	2,40
				160	2,60
				200	2,81
				250	3,11
				315	3,42
				400	4,38
3	0,3	10	5,2	100	2,87
				200	3,67
				400	6,06
				500	8,13
				630	8,96
				800	10,90
3	0,3	10	5,5	100	3,05
				125	3,23
				160	3,34
				200	3,77
				250	4,35
				315	4,87
				400	6,34
				500	8,47
				630	10,93
				800	12,11



## KIHO

Hengeres fejű kilökö, nitridált, eloxált  
 Auswerferstift, nitriert, oxidiert  
 Ejector pin, nitrided and oxidized  
 DIN ISO 6751 (DIN 1530-1)

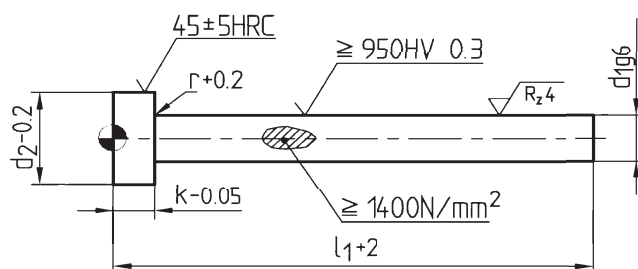

Rendelési példa: }  
 Bestell-Beispiel: } **KIHO-d1xl<sub>1</sub>**  
 Order example: }

Anyag: }  
 Werkstoff: } **1.2343**  
 Material: }

k	r	d <sub>2</sub>	d <sub>1</sub>	l <sub>1</sub>	€
5	0,5	12	6	40	2,34
				63	2,34
				80	2,34
				100	2,34
				125	2,60
				160	2,78
				200	3,03
				250	3,46
				315	3,93
				400	5,07
5	0,5	12	6,2	100	3,17
				200	4,32
				400	7,55
				500	9,30
				630	10,93
				800	12,11
				5	0,5
63	3,41				
80	3,41				
100	3,41				
125	3,76				
160	3,89				
200	4,64				
250	5,52				
315	6,25				
400	8,39				
5	0,5	12	7	100	3,58
				125	3,93
				160	4,16
				200	4,87
				250	5,72
				315	6,41
				400	8,72
				500	10,70
				630	12,11
				800	18,27
5	0,5	14	8	63	2,65
				80	2,65
				100	2,65
				125	2,98
				160	3,27
				200	3,73
				250	4,38

k	r	d <sub>2</sub>	d <sub>1</sub>	l <sub>1</sub>	€				
5	0,5	14	8	315	4,75				
				400	6,62				
				500	8,14				
				630	9,86				
				800	12,11				
				5	0,5	14	8,2	100	4,49
200	5,83								
400	10,13								
500	12,80								
630	15,95								
800	18,27								
5	0,5	14	8,5	100	4,64				
				125	4,95				
				160	5,24				
				200	6,11				
				250	7,04				
				315	8,16				
				400	10,70				
5	0,5	14	8,5	500	13,42				
				630	16,54				
				800	23,38				
				5	0,5	14	9	80	4,90
								100	4,90
								125	5,16
160	5,60								
200	6,33								
250	7,27								
5	0,5	14	9	315	8,44				
				400	11,10				
				500	13,94				
				630	17,36				
				800	23,38				
				5	0,5	16	10	100	3,38
125	3,74								
160	4,17								
200	5,13								
250	5,72								
315	6,51								
400	9,59								
500	11,98								
630	14,54								
800	17,80								
5	0,5	16	10,2	100	5,78				
				200	7,75				
				400	13,30				
				500	16,24				
				630	20,04				
				800	23,38				

## KIHO

Hengeres fejű kilőkő, nitridált, eloxált  
 Auswerferstift, nitriert, oxidiert  
 Ejector pin, nitrided and oxidized  
 DIN ISO 6751 (DIN 1530-1)

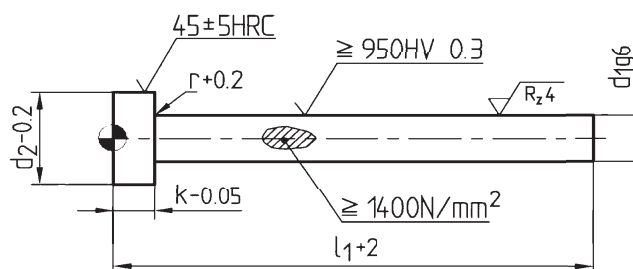

Rendelési példa: }  
 Bestell-Beispiel: } **KIHO-d1xl<sub>1</sub>**  
 Order example: }

Anyag: }  
 Werkstoff: } **1.2343**  
 Material: }

k	r	d <sub>2</sub>	d <sub>1</sub>	l <sub>1</sub>	€
5	0,5	16	10,5	100	6,26
				125	6,54
				160	7,09
				200	8,41
				250	9,59
				315	10,76
				400	14,41
				500	17,64
				630	21,81
800	27,60				
5	0,5	16	11	100	6,63
				125	6,96
				160	7,47
				200	8,90
				250	10,00
				315	11,39
				400	15,20
				500	18,61
				630	22,94
800	27,60				
7	0,8	18	12	80	4,54
				100	4,54
				125	5,23
				160	5,98
				200	7,33
				250	9,04
				315	9,95
				400	12,89
				500	16,41
630	19,92				
800	23,61				
7	0,8	18	12,2	100	5,54
				125	6,81
				160	7,71
				200	8,58
				250	9,64
				315	11,25
				400	15,15
				500	19,50
				630	23,38
800	27,60				
7	0,8	18	12,5	100	5,54
				125	6,81
				160	7,71
				200	8,58
				250	9,64
				315	11,25
				400	15,15
				500	19,50
				630	23,38
800	27,60				

k	r	d <sub>2</sub>	d <sub>1</sub>	l <sub>1</sub>	€
7	0,8	22	14	100	6,32
				125	8,30
				160	8,52
				200	9,85
				250	11,03
				315	12,11
				400	16,51
				500	20,33
				630	25,49
800	30,06				
7	0,8	22	16	100	7,39
				125	9,12
				160	9,49
				200	11,43
				250	13,08
				315	14,68
				400	18,76
				500	24,30
				630	31,93
800	42,81				
7	0,8	24	18	100	9,12
				125	9,90
				160	11,59
				200	15,11
				250	18,37
				315	21,88
				400	25,53
				500	34,39
				630	41,94
800	51,58				
8	1	26	20	100	10,90
				125	10,90
				160	11,28
				200	15,51
				250	18,09
				315	21,69
				400	30,68
				500	39,37
				630	48,57
800	61,10				
10	1	32	25	100	21,73
				125	21,73
				160	21,73
				200	25,97
				250	31,26
				315	36,48
				400	44,23
				500	56,75
				630	70,30
800	96,12				

## KIHN

Hengeres fejű kilökö, nitridált  
 Auswerferstift, nitriert, blank  
 Ejector pin, nitrided  
 DIN ISO 6751 (DIN 1530-1)

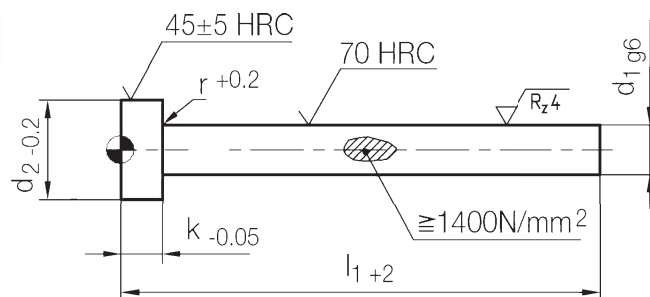

Rendelési példa: }  
 Bestell-Beispiel: } **KIHN-d1xl<sub>1</sub>**  
 Order example: }

Anyag: }  
 Werkstoff: } **1.2343**  
 Material: }

k	r	d <sub>2</sub>	d <sub>1</sub>	l <sub>1</sub>	€
1,2	0,2	2,5	1	40	3,17
				63	3,17
				80	3,17
				100	3,17
				125	3,33
				160	3,75
				200	5,00
1,2	0,2	2,5	1,1	40	3,33
				63	3,33
				80	3,33
				100	3,33
				125	3,75
				160	4,17
				200	5,17
1,2	0,2	2,5	1,2	40	3,33
				63	3,33
				80	3,33
				100	3,33
				125	3,75
				160	4,17
				200	5,17
1,5	0,2	3	1,3	40	3,33
				63	3,33
				80	3,33
				100	3,33
				125	3,75
				160	4,17
				200	5,17
1,5	0,2	3	1,4	40	3,33
				63	3,33
				80	3,33
				100	3,33
				125	3,75
				160	4,17
				200	5,17
1,5	0,2	3	1,5	40	3,06
				63	3,06
				80	3,06
				100	3,06
				125	3,33
				160	3,48
				200	3,82
1,5	0,2	3	1,6	40	2,25
				63	2,25
				80	2,25
				100	2,25
				125	2,67
				160	2,92
				200	3,83

k	r	d <sub>2</sub>	d <sub>1</sub>	l <sub>1</sub>	€
1,5	0,2	3	1,7	40	2,25
				63	2,25
				80	2,25
				100	2,25
				125	2,67
				160	2,92
				200	3,83
1,5	0,2	3	1,8	40	2,25
				63	2,25
				80	2,25
				100	2,25
				125	2,67
				160	2,92
				200	3,83
1,5	0,2	3	1,9	40	2,25
				63	2,25
				80	2,25
				100	2,25
				125	2,67
				160	2,92
				200	3,83
2	0,2	4	2	40	2,17
				63	2,17
				80	2,17
				100	2,17
				125	2,30
				160	2,41
				200	2,64
2	0,2	4	2,2	250	2,86
				315	3,55
				100	2,33
				200	2,85
2	0,2	4	2,2	315	3,55
				40	2,47
				63	2,47
2	0,3	5	2,5	80	2,47
				100	2,47
				125	2,61
				160	2,72
				200	3,05
				250	3,08
				315	3,55
2	0,3	5	2,7	100	2,48
				200	3,06
				315	4,08
				40	2,47

## KIHN

Hengeres fejű kilökö, nitridált  
 Auswerferstift, nitriert, blank  
 Ejector pin, nitrided  
 DIN ISO 6751 (DIN 1530-1)

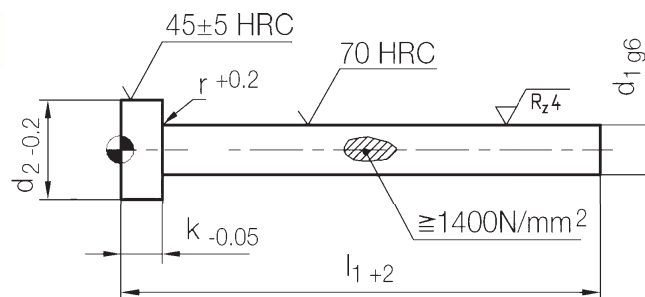

Rendelési példa: }  
 Bestell-Beispiel: } **KIHN-d1xl1**  
 Order example: }

Anyag: }  
 Werkstoff: } **1.2343**  
 Material: }

k	r	d <sub>2</sub>	d <sub>1</sub>	l <sub>1</sub>	€
3	0,3	6	3	40	1,99
				63	1,99
				80	1,99
				100	1,99
				125	2,07
				160	2,18
				200	2,42
				250	2,71
				315	2,97
				400	3,73
500	4,28				
3	0,3	6	3,2	100	2,52
				200	3,15
				400	4,14
				500	4,53
				630	
3	0,3	7	3,5	40	2,61
				63	2,61
				80	2,61
				100	2,61
				125	2,82
				160	2,99
				200	3,29
				250	3,55
				315	4,01
				400	4,33
500	5,60				
3	0,3	7	3,7	100	2,84
				200	3,63
				400	5,75
				500	5,60
				630	
3	0,3	8	4	40	2,10
				63	2,10
				80	2,10
				100	2,10
				125	2,20
				160	2,26
				200	2,52
				250	2,70
				315	3,06
				400	3,87
500	4,53				
630	8,96				
800					
3	0,3	8	4,2	100	2,66
				200	3,37

k	r	d <sub>2</sub>	d <sub>1</sub>	l <sub>1</sub>	€
3	0,3	8	4,2	400	5,24
				500	8,13
				630	8,96
				800	
3	0,3	8	4,5	40	2,83
				63	2,83
				80	2,83
				100	2,83
				125	3,02
				160	3,08
				200	3,46
				250	3,76
				315	4,45
				400	5,53
500	8,13				
630	10,93				
800					
3	0,3	8	4,7	100	1,92
				200	2,83
				400	6,00
				500	7,58
				630	10,42
800	17,92				
3	0,3	10	5	40	2,25
				63	2,25
				80	2,25
				100	2,25
				125	2,40
				160	2,60
				200	2,81
				250	3,11
				315	3,42
				400	4,38
500	4,83				
630	5,60				
800	7,77				
3	0,3	10	5,2	100	2,87
				200	3,67
				400	6,06
				500	8,13
				630	8,96
800	17,09				
3	0,3	10	5,5	100	3,05
				125	3,23
				160	3,34
				200	3,77
				250	4,35
				315	4,87
				400	6,34
				500	8,47
				630	8,96
				800	12,11

## KIHN

Hengeres fejű kilökő, nitridált  
 Auswerferstift, nitriert, blank  
 Ejector pin, nitrided  
 DIN ISO 6751 (DIN 1530-1)

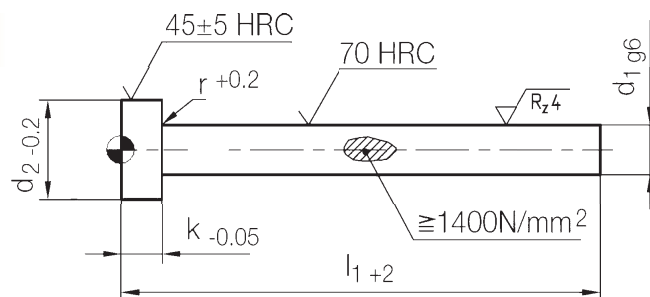

Rendelési példa: }  
 Bestell-Beispiel: } **KIHN-d1x $l_1$**   
 Order example: }

Anyag: }  
 Werkstoff: } **1.2343**  
 Material: }

k	r	d <sub>2</sub>	d <sub>1</sub>	l <sub>1</sub>	€
5	0,5	12	6	40	2,34
				63	2,34
				80	2,34
				100	2,34
				125	2,60
				160	2,78
				200	3,03
				250	3,46
				315	3,93
				400	5,07
5	0,5	12	6,2	100	3,17
				200	4,32
				400	7,55
				500	9,30
				630	10,93
				800	12,11
				5	0,5
63	3,41				
80	3,41				
100	3,41				
125	3,76				
160	3,89				
200	4,64				
250	5,52				
315	6,25				
400	8,39				
500	10,20				
630	12,11				
800	17,09				
5	0,5	12	7	100	3,58
				125	3,93
				160	4,16
				200	4,87
				250	5,72
				315	6,41
				400	8,72
				500	10,70
				630	12,11
				800	17,09
5	0,5	14	8	63	2,65
				80	2,65
				100	2,65
				125	2,98
				160	3,27
				200	3,73
				250	4,38

k	r	d <sub>2</sub>	d <sub>1</sub>	l <sub>1</sub>	€
5	0,5	14	8	315	4,75
				400	6,62
				500	8,14
				630	9,86
				800	12,11
				5	0,5
200	5,83				
400	10,13				
500	12,80				
630	15,95				
800	18,27				
5	0,5	14	8,5	100	4,64
				125	4,95
				160	5,24
				200	6,11
				250	7,04
				315	8,16
				400	10,70
500	13,42				
630	16,54				
800	17,80				
5	0,5	14	9	80	4,90
				100	4,90
				125	5,16
				160	5,60
				200	6,33
				250	7,27
				315	8,44
				400	11,10
				500	13,94
				630	17,36
800	18,69				
5	0,5	16	10	100	3,38
				125	3,74
				160	4,17
				200	5,13
				250	5,72
				315	6,51
				400	9,59
				500	11,98
				630	14,54
				800	17,80
5	0,5	16	10,2	100	5,78
				200	7,75
				400	13,30
				500	16,24
				630	20,04
				800	23,38

## KIHN

Hengeres fejű kilökö, nitridált  
 Auswerferstift, nitriert, blank  
 Ejector pin, nitrided  
 DIN ISO 6751 (DIN 1530-1)

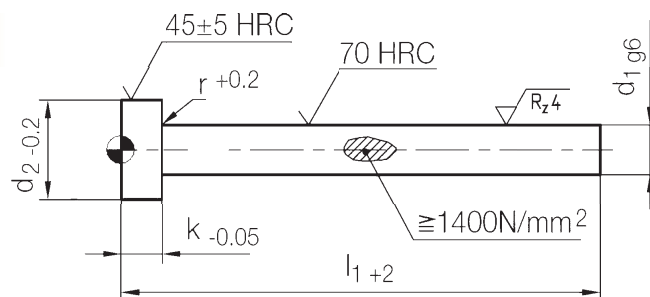

Rendelési példa: }  
 Bestell-Beispiel: } **KIHN-d1xl1**  
 Order example: }

Anyag: }  
 Werkstoff: } **1.2343**  
 Material: }

k	r	d <sub>2</sub>	d <sub>1</sub>	l <sub>1</sub>	€
5	0,5	16	10,5	100	6,26
				125	6,54
				160	7,09
				200	8,41
				250	9,59
				315	10,76
				400	14,41
				500	17,64
				630	21,81
800	23,61				
5	0,5	16	11	100	6,63
				125	6,96
				160	7,47
				200	8,90
				250	10,00
				315	11,39
				400	15,20
				500	18,61
				630	22,94
800	23,61				
7	0,8	18	12	80	4,54
				100	4,54
				125	5,23
				160	5,98
				200	7,33
				250	9,04
				315	9,95
				400	12,89
				500	16,41
630	19,92				
800	23,61				
7	0,8	18	12,2	100	5,54
				125	6,81
				160	7,71
				200	8,58
				250	9,64
				315	11,25
				400	15,15
				500	19,50
				630	23,38
800	27,60				
7	0,8	18	12,5	100	5,54
				125	6,81
				160	7,71
				200	8,58
				250	9,64
				315	11,25
				400	15,15
				500	19,50
				630	23,38
800	27,60				

k	r	d <sub>2</sub>	d <sub>1</sub>	l <sub>1</sub>	€
7	0,8	22	14	100	6,32
				125	8,30
				160	8,52
				200	9,85
				250	11,03
				315	12,11
				400	16,51
				500	20,33
				630	25,49
800	30,06				
7	0,8	22	16	100	7,39
				125	9,12
				160	9,49
				200	11,43
				250	13,08
				315	14,68
				400	18,76
				500	24,30
				630	31,93
800	42,81				
7	0,8	24	18	100	9,12
				125	9,90
				160	11,59
				200	15,11
				250	18,37
				315	21,88
				400	25,53
				500	34,39
				630	41,94
800	51,58				
8	1	26	20	100	10,90
				125	10,90
				160	11,28
				200	15,51
				250	18,09
				315	21,69
				400	30,68
				500	39,37
				630	48,57
800	61,10				
10	1	32	25	100	21,73
				125	21,73
				160	21,73
				200	25,97
				250	31,26
				315	36,48
				400	44,23
				500	56,75
				630	70,30
800	96,12				

## KIMF

### Magformázó kilökő

Kernstift, gehärtet, unnitriert

Core pin, hardened, non-nitrided

DIN ISO 6751 (DIN 1530-1)

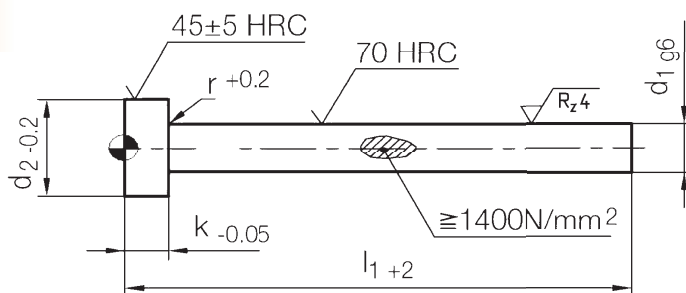

Rendelési példa:

Bestell-Beispiel:

Order example:

KIMF-d1x $l_1$

Anyag:

Werkstoff:

Material:

1.2343

k	r	d <sub>2</sub>	d <sub>1</sub>	l <sub>1</sub>	€
1,2	0,2	2,5	1	40	3,17
				63	3,17
				80	3,17
				100	3,17
				125	3,33
				160	3,75
				200	5,00
1,2	0,2	2,5	1,1	40	3,33
				63	3,33
				80	3,33
				100	3,33
				125	3,75
				160	4,17
				200	5,17
1,2	0,2	2,5	1,2	40	3,33
				63	3,33
				80	3,33
				100	3,33
				125	3,75
				160	4,17
				200	5,17
1,5	0,2	3	1,3	40	3,33
				63	3,33
				80	3,33
				100	3,33
				125	3,75
				160	4,17
				200	5,17
1,5	0,2	3	1,4	40	3,33
				63	3,33
				80	3,33
				100	3,33
				125	3,75
				160	4,17
				200	5,17
1,5	0,2	3	1,5	40	2,25
				63	2,25
				80	2,25
				100	2,25
				125	2,67
				160	2,92
				200	3,83
1,5	0,2	3	1,6	40	2,25
				63	2,25
				80	2,25
				100	2,25
				125	2,67
				160	2,92
				200	3,83

k	r	d <sub>2</sub>	d <sub>1</sub>	l <sub>1</sub>	€
1,5	0,2	3	1,7	40	2,25
				63	2,25
				80	2,25
				100	2,25
				125	2,67
				160	2,92
				200	3,83
1,5	0,2	3	1,8	40	2,25
				63	2,25
				80	2,25
				100	2,25
				125	2,67
				160	2,92
				200	3,83
1,5	0,2	3	1,9	40	2,25
				63	2,25
				80	2,25
				100	2,25
				125	2,67
				160	2,92
				200	3,83
2	0,2	4	2	40	2,08
				63	2,08
				80	2,08
				100	2,08
				125	2,33
				160	2,50
				200	3,17
2	0,2	4	2,2	100	2,08
				200	3,17
				315	4,17
				315	4,17
2	0,3	5	2,5	40	1,67
				63	1,67
				80	1,67
				100	1,67
				125	1,83
				160	2,33
2	0,3	5	2,7	100	1,67
				200	2,67
				315	4,08
				315	4,08
				315	4,08
				315	4,08

## KIMF

### Magformázó kilökö

Kernstift, gehärtet, unnitriert

Core pin, hardened, non-nitrided

DIN ISO 6751 (DIN 1530-1)

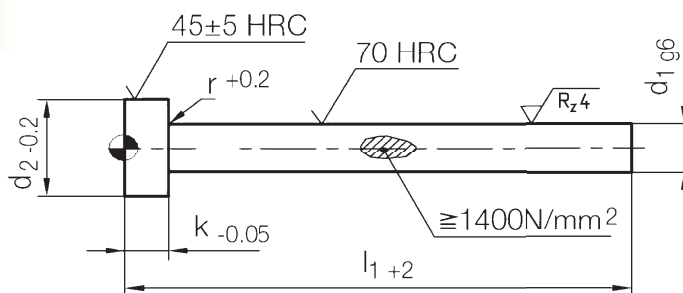

Rendelési példa:

Bestell-Beispiel:

Order example:

KIMF-d1x $l_1$

Anyag:

Werkstoff:

Material:

1.2343

k	r	d <sub>2</sub>	d <sub>1</sub>	l <sub>1</sub>	€
3	0,3	6	3	40	1,58
				63	1,58
				80	1,58
				100	1,58
				125	1,67
				160	2,17
				200	2,50
				250	2,67
				315	3,83
				400	5,42
500	6,25				
630					
800					
3	0,3	6	3,2	100	1,83
				200	2,67
				400	5,08
				500	7,67
				630	
800					
3	0,3	7	3,5	40	1,92
				63	1,92
				80	1,92
				100	1,92
				125	2,08
				160	2,33
				200	2,75
				250	3,00
				315	4,17
				400	5,75
500	7,67				
630					
800					
3	0,3	7	3,7	100	2,08
				200	2,92
				400	6,25
				500	7,67
				630	
800					
3	0,3	8	4	40	1,83
				63	1,83
				80	1,83
				100	1,83
				125	1,92
				160	2,25
				200	2,58
				250	3,08
				315	3,83
				400	5,00
500	7,08				
630	12,92				
800					
3	0,3	8	4,2	100	2,08
				200	3,00

k	r	d <sub>2</sub>	d <sub>1</sub>	l <sub>1</sub>	€
3	0,3	8	4,2	400	6,67
				500	9,33
				630	12,92
				800	
3	0,3	8	4,5	40	1,92
				63	1,92
				80	1,92
				100	1,92
				125	2,17
				160	2,50
				200	2,92
				250	3,58
				315	4,58
				400	6,25
500	8,33				
630	12,92				
800					
3	0,3	8	4,7	100	1,92
				200	2,83
				400	6,00
				500	7,58
				630	10,42
800	17,92				
3	0,3	10	5	40	1,92
				63	1,92
				80	1,92
				100	1,92
				125	2,08
				160	2,58
				200	2,83
				250	3,50
				315	4,50
				400	6,00
500	7,58				
630	10,42				
800	17,92				
3	0,3	10	5,2	100	2,67
				200	4,00
				400	8,33
				500	10,83
				630	14,58
800	20,83				
3	0,3	10	5,5	100	2,50
				125	2,75
				160	3,25
				200	3,75
				250	4,58
				315	6,25
				400	8,25
				500	10,67
				630	14,58
				800	20,83



## KIMF

### Magformázó kilökő

Kernstift, gehärtet, unnitriert

Core pin, hardened, non-nitrided

DIN ISO 6751 (DIN 1530-1)

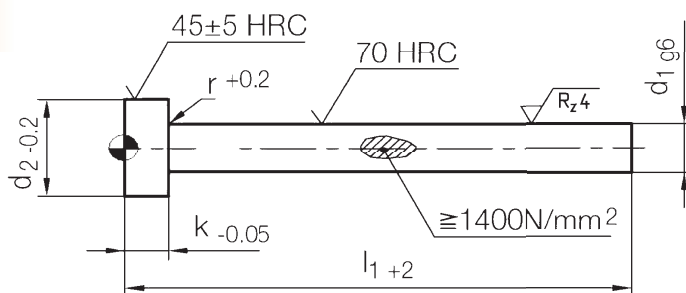

Rendelési példa:

Bestell-Beispiel:

Order example:

KIMF-d1xl<sub>1</sub>

Anyag:

Werkstoff:

Material:

1.2343

k	r	d <sub>2</sub>	d <sub>1</sub>	l <sub>1</sub>	€				
5	0,5	12	6	40	2,75				
				63	2,75				
				80	2,75				
				100	2,75				
				125	3,00				
				160	3,67				
				200	3,92				
				250	5,00				
				315	6,67				
				400	8,50				
5	0,5	12	6,2	100	3,08				
				200	4,67				
				400	9,58				
				500	12,92				
				630	20,83				
				800	31,67				
				5	0,5	12	6,5	40	3,08
								63	3,08
80	3,08								
100	3,08								
125	3,50								
160	4,25								
200	4,67								
250	5,67								
315	7,67								
400	9,83								
5	0,5	12	7	100	3,08				
				125	3,50				
				160	4,25				
				200	4,67				
				250	5,67				
				315	7,67				
				400	9,83				
				500	12,92				
				630	20,83				
				800	31,67				
5	0,5	14	8	63	3,58				
				80	3,58				
				100	3,58				
				125	4,25				
				160	5,00				
				200	5,50				
				250	6,67				

k	r	d <sub>2</sub>	d <sub>1</sub>	l <sub>1</sub>	€				
5	0,5	14	8	315	8,33				
				400	11,25				
				500	14,83				
				630	19,17				
				800	32,50				
				5	0,5	14	8,2	100	4,75
200	7,17								
400	17,08								
500	24,17								
630	35,00								
800	43,75								
5	0,5	14	8,5					100	4,75
								125	5,50
				160	6,92				
				200	7,17				
				250	9,33				
				315	10,83				
				400	17,08				
				500	24,17				
5	0,5	14	9	80	4,75				
				100	4,75				
				125	5,50				
				160	6,92				
				200	7,17				
				250	9,33				
				315	10,83				
				400	17,08				
5	0,5	16	10	100	4,92				
				125	5,67				
				160	7,08				
				200	7,75				
				250	10,08				
				315	12,08				
				400	17,92				
				500	25,67				
				630	40,00				
				800	57,92				
5	0,5	16	10,2	100	6,25				
				200	9,08				
				400	20,42				
				500	30,00				
				630	42,50				
				800	57,92				

## KIMF

### Magformázó kilökő

Kernstift, gehärtet, unnitriert

Core pin, hardened, non-nitrided

DIN ISO 6751 (DIN 1530-1)

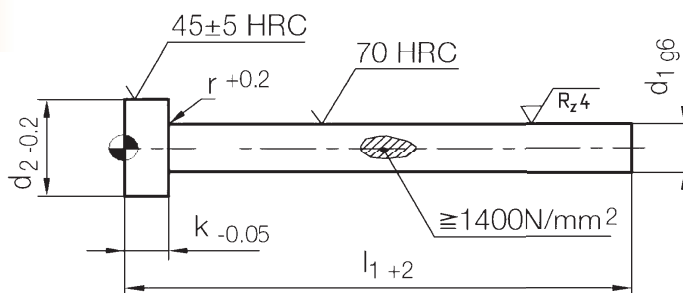

Rendelési példa:

Bestell-Beispiel:

Order example:

KIMF-d1xl<sub>1</sub>

Anyag:

Werkstoff:

Material:

1.2343

k	r	d <sub>2</sub>	d <sub>1</sub>	l <sub>1</sub>	€
5	0,5	16	10,5	100	6,92
				125	7,83
				160	9,67
				200	10,08
				250	12,50
				315	17,00
				400	21,67
				500	30,42
				630	43,00
800	62,50				
5	0,5	16	11	100	6,67
				125	7,83
				160	9,67
				200	10,58
				250	12,92
				315	17,00
				400	22,08
				500	30,42
				630	43,00
800	62,50				
7	0,8	18	12	80	6,83
				100	6,83
				125	7,92
				160	10,00
				200	10,83
				250	13,17
				315	17,08
				400	22,50
				500	30,42
630	43,00				
800	62,50				
7	0,8	18	12,2	100	7,92
				125	8,75
				160	11,83
				200	13,33
				250	15,50
				315	20,42
				400	29,83
				500	41,67
				630	45,42
800	79,17				
7	0,8	18	12,5	100	8,50
				125	10,42
				160	13,25
				200	16,25
				250	19,92
				315	24,58
				400	33,33
				500	39,25
				630	52,08
800	79,17				

k	r	d <sub>2</sub>	d <sub>1</sub>	l <sub>1</sub>	€
7	0,8	22	14	100	8,50
				125	10,42
				160	13,25
				200	16,25
				250	19,92
				315	24,58
				400	33,33
				500	39,25
				630	52,08
800	79,17				
7	0,8	22	16	100	11,83
				125	13,75
				160	16,83
				200	22,42
				250	27,42
				315	30,42
				400	51,67
				500	52,50
				630	65,00
800	93,33				
7	0,8	24	18	100	18,17
				125	20,00
				160	22,92
				200	26,75
				250	33,17
				315	41,67
				400	58,33
				500	83,17
				630	108,17
800	140,00				
8	1	26	20	100	19,58
				125	23,33
				160	24,75
				200	30,50
				250	36,50
				315	46,67
				400	70,00
				500	83,33
				630	108,33
800	165,00				
10	1	32	25	100	23,50
				125	28,00
				160	29,70
				200	36,60
				250	43,80
				315	56,00
				400	84,00
				500	100,00
				630	130,00
800	198,00				

## KIKA

**Kúpos fejű kilökö, edzett**  
**Auswerferstift, gehärtet**  
**Ejector pin, hardened**  
**DIN1530-3**

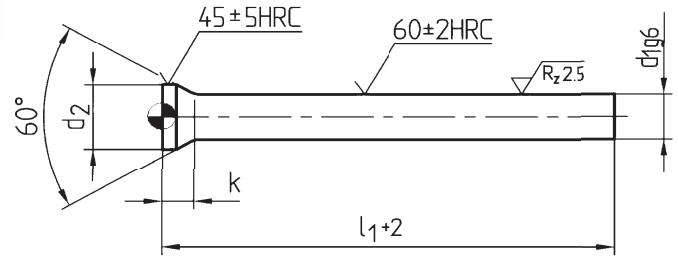

Rendelési példa: }  
 Bestell-Beispiel: } **KIKA-d1xl<sub>1</sub>**  
 Order example: }

Anyag: }  
 Werkstoff: } **1.2516**  
 Material: }

k	d <sub>2</sub>	d <sub>1</sub>	l <sub>1</sub>	€
1,2	1,8	1	80	1,09
			100	1,09
			125	1,22
			160	1,29
			200	1,56
1,1	1,8	1,1	80	1,09
			100	1,22
			125	1,22
			160	1,29
			200	1,56
1,2	2	1,2	80	1,09
			100	1,15
			125	1,22
			160	1,29
			200	1,56
1,1	2	1,3	80	1,09
			100	1,15
			125	1,22
			160	1,29
			200	1,56
1,2	2,2	1,4	80	1,09
			100	1,15
			125	1,22
			160	1,29
			200	1,56
1,1	2,2	1,5	80	1,09
			100	1,15
			125	1,22
			160	1,29
			200	1,56
1,3	2,5	1,6	80	1,09
			100	1,15
			125	1,22
			160	1,29
			200	1,56
1,2	2,5	1,7	80	1,09
			100	1,15
			125	1,22
			160	1,29
			200	1,56
1,4	2,8	1,8	80	1,09
			100	1,15
			125	1,22
			160	1,29
			200	1,56
1,3	2,8	1,9	80	1,09
			100	1,15
			125	1,22
			160	1,29
			200	1,56

k	d <sub>2</sub>	d <sub>1</sub>	l <sub>1</sub>	€
1,4	3	2	80	1,09
			100	1,22
			125	1,22
			160	1,29
			200	1,56
1,5	3,2	2,1	80	1,09
			100	1,15
			125	1,15
			160	1,29
			200	1,56
1,4	3,2	2,2	80	1,09
			100	1,15
			125	1,15
			160	1,29
			200	1,56
1,5	3,5	2,3	80	1,09
			100	1,15
			125	1,15
			160	1,29
			200	1,56
1,5	3,5	2,4	80	1,09
			100	1,15
			125	1,15
			160	1,29
			200	1,56
1,4	3,5	2,5	80	0,95
			100	0,95
			125	1,02
			160	1,09
			200	1,43
1,7	4	2,6	80	0,95
			100	0,95
			125	1,02
			160	1,09
			200	1,43
1,4	3,5	2,5	250	2,04
			315	2,85
			80	0,95
			100	0,95
			125	1,02
1,3	2,8	1,9	160	1,09
			200	1,43
			250	2,04
			315	2,85
			80	0,95

## KIKA

**Kúpos fejű kilökő, edzett**  
**Auswerferstift, gehärtet**  
**Ejector pin, hardened**  
**DIN1530-3**

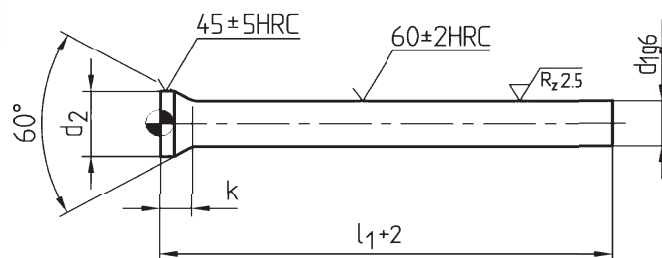

Rendelési példa: }  
 Bestell-Beispiel: } **KIKA-d1xl<sub>1</sub>**  
 Order example: }

Anyag: }  
 Werkstoff: } **1.2516**  
 Material: }

k	d <sub>2</sub>	d <sub>1</sub>	l <sub>1</sub>	€
1,6	4	2,7	80	0,95
			100	0,95
			125	1,02
			160	1,09
			200	1,43
			250	2,04
1,5	4	2,8	80	0,95
			100	0,95
			125	1,02
			160	1,09
			200	1,43
			250	2,04
1,5	4	2,9	80	0,95
			100	0,95
			125	1,09
			160	1,15
			200	1,43
			250	2,04
1,8	4,5	3	80	0,75
			100	0,75
			125	0,88
			160	0,95
			200	1,15
			250	1,56
		3,2	80	0,81
			100	0,88
			125	1,02
			160	1,09
			200	1,29
			250	1,70
1,8	5	3,5	80	0,81
			100	0,88
			125	1,02
			160	1,09
			200	1,29
			250	1,70
		3,7	80	0,88
			100	0,95
			125	1,15
			160	1,22
			200	1,43
			250	1,83
			315	2,38
			315	2,85

k	d <sub>2</sub>	d <sub>1</sub>	l <sub>1</sub>	€
1,8	5,5	4	80	0,88
			100	0,95
			125	1,09
			160	1,22
			200	1,43
			250	1,83
		4,2	80	0,95
			100	1,09
			125	1,22
			160	1,36
			200	1,56
			250	2,04
1,8	6	4,5	80	0,95
			100	1,02
			125	1,22
			160	1,36
			200	1,56
			250	2,04
		4,7	80	1,09
			100	1,15
			125	1,36
			160	1,49
			200	1,70
			250	2,24
1,8	6,5	5	80	1,09
			100	1,09
			125	1,43
			160	1,49
			200	1,70
			250	2,24
		5,2	80	1,22
			100	1,29
			125	1,49
			160	1,83
			200	2,17
			250	2,85
1,8	7	5,5	80	1,22
			100	1,29
			125	1,56
			160	1,83
			200	2,17
			250	2,85
			315	3,73
			315	3,73

## KIKA

**Kúpos fejű kilökö, edzett**  
**Auswerferstift, gehärtet**  
**Ejector pin, hardened**  
**DIN1530-3**

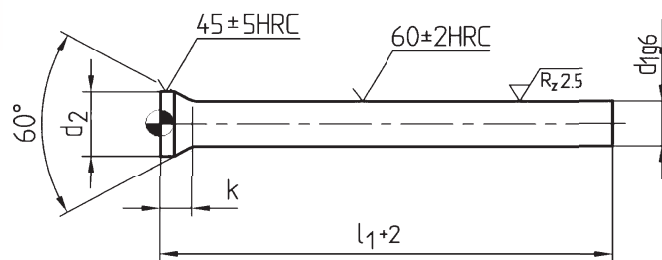

Rendelési példa: }  
 Bestell-Beispiel: } **KIKA-d1xl<sub>1</sub>**  
 Order example: }

Anyag: }  
 Werkstoff: } **1.2516**  
 Material: }

k	d <sub>2</sub>	d <sub>1</sub>	l <sub>1</sub>	€
2,2	8	6	80	1,36
			100	1,43
			125	1,63
			160	2,17
			200	2,58
			250	3,46
			315	4,62
		6,2	80	1,97
			100	2,10
			125	2,38
			160	2,72
			200	3,26
			250	4,34
			315	5,70
3,2	9	6,5	80	1,97
			100	2,10
			125	2,38
			160	2,72
			200	3,26
			250	4,34
			315	5,70
2,7	9	7	80	1,97
			100	2,10
			125	2,38
			160	2,58
			200	3,26
			250	4,34
			315	5,70
3,2	10	7,5	80	2,38
			100	2,38
			125	2,85
			160	2,78
			200	3,73
			250	4,96
			315	6,38
2,7	10	8	80	2,38
			100	2,44
			125	2,85
			160	2,92
			200	3,73
			250	4,75
			315	6,38
		8,2	80	2,78
			100	2,92
			125	3,19
			160	3,53
			200	4,28
			250	5,63
			315	7,13

k	d <sub>2</sub>	d <sub>1</sub>	l <sub>1</sub>	€
3,2	11	8,5	80	2,78
			100	2,92
			125	3,19
			160	3,53
			200	4,28
			250	5,63
			315	7,13
2,7	11	9	80	2,78
			100	2,92
			125	3,19
			160	3,53
			200	4,28
			250	5,63
			315	7,13
2,7	12	10	80	2,92
			100	3,05
			125	3,33
			160	3,80
			200	4,75
			250	6,18
			315	7,81
		10,2	80	3,67
			100	3,87
			125	4,34
			160	4,75
			200	5,77
			250	8,08
			315	10,18
		10,5	80	3,67
			100	3,94
			125	4,34
			160	4,75
			200	5,77
			250	8,08
			315	10,18
		11	80	3,67
			100	3,94
			125	4,34
			160	4,75
			200	5,77
			250	8,08
			315	10,18
2,7	14	12	80	4,14
			100	4,21
			125	4,41
			160	5,23
			200	6,52
			250	9,30
			315	11,88

## KIKA

**Kúpos fejű kilökö, edzett**  
**Auswerferstift, gehärtet**  
**Ejector pin, hardened**  
**DIN1530-3**

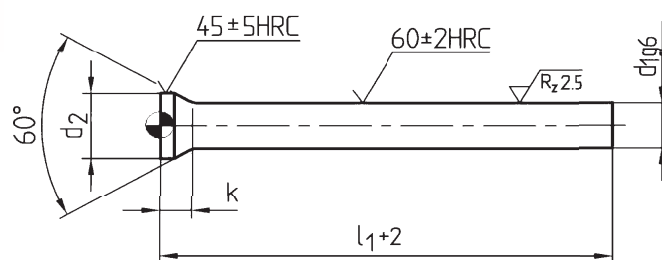

Rendelési példa: }  
 Bestell-Beispiel: } **KIKA-d1xl<sub>1</sub>**  
 Order example: }

Anyag: }  
 Werkstoff: } **1.2516**  
 Material: }

k	d <sub>2</sub>	d <sub>1</sub>	l <sub>1</sub>	€
2,7	14	12,2	80	5,91
			100	6,24
			125	6,72
			160	7,53
			200	9,37
			250	11,81
			315	16,36
		12,5	80	5,91
			100	6,24
			125	6,72
			160	7,53
			200	9,37
			250	12,01
			315	16,36
3,2	16	14	80	7,13
			100	7,47
			125	8,01
			160	8,82
			200	11,20
			250	13,44
			315	19,35

k	d <sub>2</sub>	d <sub>1</sub>	l <sub>1</sub>	€
3,2	18	16	80	9,10
			100	9,57
			125	10,05
			160	11,47
			200	14,53
			250	16,22
			315	25,66
		18	80	10,32
			100	10,79
			125	11,61
			160	12,56
			200	16,09
			250	20,16
			315	30,21
		20	80	11,47
			100	12,08
			125	13,17
			160	13,58
			200	17,65
			250	24,10
			315	35,64

## KIEA

**Erősített szárú kilökö, edzett**  
**Auswerferstift, abgesetzt, gehärtet**  
**Ejector pin, stepped, hardened**  
**DIN ISO 8694**

Rendelési példa: }  
 Bestell-Beispiel: } **KIEA-d1xl<sub>1</sub>**  
 Order example: }

Anyag: }  
 Werkstoff: } **1.2516**  
 Material: }

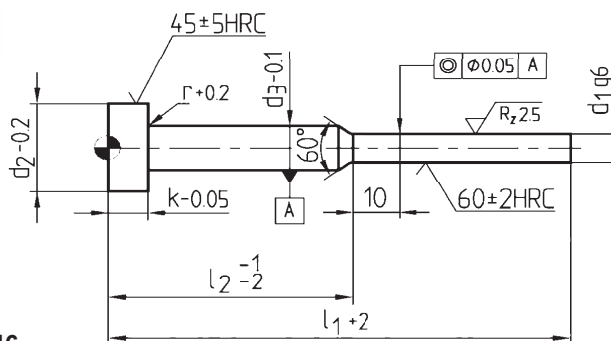

k	r	d <sub>3</sub>	d <sub>2</sub>	d <sub>1</sub>	l <sub>1</sub>	l <sub>2</sub>	€
2	0,2	2	4	0,8	80	50	4,85
					100	50	5,12
					125	50	5,39
					160	63	6,06
					200	80	6,74
2	0,2	2	4	0,9	80	50	4,85
					100	50	5,12
					125	50	5,39
					160	63	6,06
					200	80	6,74
2	0,2	2	4	1	80	50	4,85
					100	50	5,12
					125	50	5,39
					160	63	6,06
					200	80	6,74
2	0,2	2	4	1.1	80	50	4,85
					100	50	5,12
					125	50	5,39
					160	63	6,06
					200	80	6,74
2	0,2	2	4	1.2	80	50	4,85
					100	50	5,12
					125	50	5,39
					160	63	6,06
					200	80	6,74
2	0,2	2	4	1.3	80	50	4,85
					100	50	5,12
					125	50	5,39
					160	63	6,06
					200	80	6,74
2	0,2	2	4	1.4	80	50	4,85
					100	50	5,12
					125	50	5,39
					160	63	6,06
					200	80	6,74
3	0,3	3	6	1,5	80	50	4,31
					100	50	4,45
					125	50	4,99
					160	63	5,39
					200	80	5,66
3	0,3	3	6	1,6	80	50	4,31
					100	50	4,45
					125	50	4,99
					160	63	5,39
					200	80	5,66
3	0,3	3	6	1,7	80	50	4,31
					100	50	4,45
					125	50	4,99
					160	63	5,39
					200	80	5,66
3	0,3	3	6	1,8	80	50	4,31
					100	50	4,45
					125	50	4,99
					160	63	5,39
					200	80	5,66

d <sub>3</sub>	d <sub>2</sub>	k	l <sub>2</sub>	r	d <sub>1</sub>	l <sub>1</sub>	€
3	0,3	3	6	1,9	80	50	4,31
					100	50	4,45
					125	50	4,99
					160	63	5,39
					200	80	5,66
3	0,3	3	6	2	80	50	5,12
					100	50	5,39
					125	50	5,66
					160	63	5,79
					200	80	6,47
3	0,3	3	6	2,1	80	50	5,12
					100	50	5,39
					125	50	5,66
					160	63	5,79
					200	80	6,47
3	0,3	3	6	2,2	80	50	5,12
					100	50	5,39
					125	50	5,66
					160	63	5,79
					200	80	6,47
3	0,3	3	6	2,3	80	50	5,12
					100	50	5,39
					125	50	5,66
					160	63	5,79
					200	80	6,47
3	0,3	3	6	2,4	80	50	5,12
					100	50	5,39
					125	50	5,66
					160	63	5,79
					200	80	6,47
3	0,3	3	6	2,5	80	50	4,72
					100	50	5,12
					125	50	5,39
					160	63	6,20
					200	80	6,74
3	0,3	3	6	2,6	80	50	4,72
					100	50	5,12
					125	50	5,39
					160	63	6,20
					200	80	6,74
3	0,3	3	6	2,7	80	50	4,72
					100	50	5,12
					125	50	5,39
					160	63	6,20
					200	80	6,74
3	0,3	3	6	2,8	80	50	4,72
					100	50	5,12
					125	50	5,39
					160	63	6,20
					200	80	6,74
3	0,3	3	6	2,9	80	50	4,72
					100	50	5,12
					125	50	5,39
					160	63	6,20
					200	80	6,74

## KIEO

**Erősített szárú kilökö, nitridált, eloxált**  
**Auswerferstift, abgesetzt, nitriert, oxidiert**  
**Ejector pin, stepped, nitrided and oxidized**  
**DIN ISO 8694**

Rendelési példa: }  
 Bestell-Beispiel: } **KIEO-d1x<sub>l</sub>**  
 Order example: }

Anyag: }  
 Werkstoff: } **1.2343**  
 Material: }

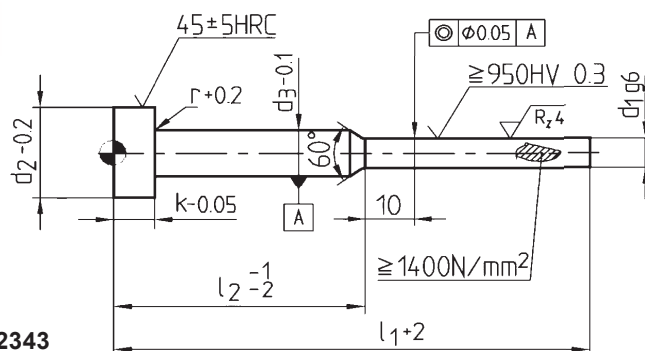

k	r	d <sub>3</sub>	d <sub>2</sub>	d <sub>1</sub>	l <sub>1</sub>	l <sub>2</sub>	€
2	0,2	2	4	0,8	80	50	6,68
					100	50	7,12
					125	50	7,55
					160	63	8,84
					200	80	10,24
2	0,2	2	4	0,9	80	50	6,68
					100	50	7,12
					125	50	7,55
					160	63	8,84
					200	80	10,24
2	0,2	2	4	1	80	50	6,68
					100	50	7,12
					125	50	7,55
					160	63	8,84
					200	80	10,24
2	0,2	2	4	1,1	80	50	6,68
					100	50	7,12
					125	50	7,55
					160	63	8,84
					200	80	10,24
2	0,2	2	4	1,2	80	50	6,68
					100	50	7,12
					125	50	7,55
					160	63	8,84
					200	80	10,24
2	0,2	2	4	1,3	80	50	6,68
					100	50	7,12
					125	50	7,55
					160	63	8,84
					200	80	10,24
2	0,2	2	4	1,4	80	50	6,68
					100	50	7,12
					125	50	7,55
					160	63	8,84
					200	80	10,24
3	0,3	3	6	1,5	80	50	5,71
					100	50	6,25
					125	50	6,68
					160	63	8,09
					200	80	9,49
3	0,3	3	6	1,6	80	50	5,71
					100	50	6,25
					125	50	6,68
					160	63	8,09
					200	80	9,49
3	0,3	3	6	1,7	80	50	5,71
					100	50	6,25
					125	50	6,68
					160	63	8,09
					200	80	9,49
3	0,3	3	6	1,8	80	50	5,71
					100	50	6,25
					125	50	6,68
					160	63	8,09
					200	80	9,49

d <sub>3</sub>	d <sub>2</sub>	k	l <sub>2</sub>	r	d <sub>1</sub>	l <sub>1</sub>	€
3	0,3	3	6	1,9	80	50	5,71
					100	50	6,25
					125	50	6,68
					160	63	8,09
					200	80	9,49
3	0,3	3	6	2	80	50	7,01
					100	50	7,55
					125	50	8,09
					160	63	9,16
					200	80	10,78
3	0,3	3	6	2,1	80	50	7,01
					100	50	7,55
					125	50	8,09
					160	63	9,16
					200	80	10,78
3	0,3	3	6	2,2	80	50	7,01
					100	50	7,55
					125	50	8,09
					160	63	9,16
					200	80	10,78
3	0,3	3	6	2,3	80	50	7,01
					100	50	7,55
					125	50	8,09
					160	63	9,16
					200	80	10,78
3	0,3	3	6	2,4	80	50	7,01
					100	50	7,55
					125	50	8,09
					160	63	9,16
					200	80	10,78
3	0,3	3	6	2,5	80	50	6,47
					100	50	7,01
					125	50	7,33
					160	63	8,62
					200	80	9,92
3	0,3	3	6	2,6	80	50	6,47
					100	50	7,01
					125	50	7,33
					160	63	8,62
					200	80	9,92
3	0,3	3	6	2,7	80	50	6,47
					100	50	7,01
					125	50	7,33
					160	63	8,62
					200	80	9,92
3	0,3	3	6	2,8	80	50	6,47
					100	50	7,01
					125	50	7,33
					160	63	8,62
					200	80	9,92
3	0,3	3	6	2,9	80	50	6,47
					100	50	7,01
					125	50	7,33
					160	63	8,62
					200	80	9,92



## KIEN

**Erősített szárú kilökö, nitridált**  
**Auswerferstift, abgesetzt, nitriert**  
**Ejector pin, stepped, nitrided**  
**DIN ISO 8694**

Rendelési példa: }  
 Bestell-Beispiel: } **KIEN-d1xl<sub>1</sub>**  
 Order example: }

Anyag: }  
 Werkstoff: } **1.2343**  
 Material: }

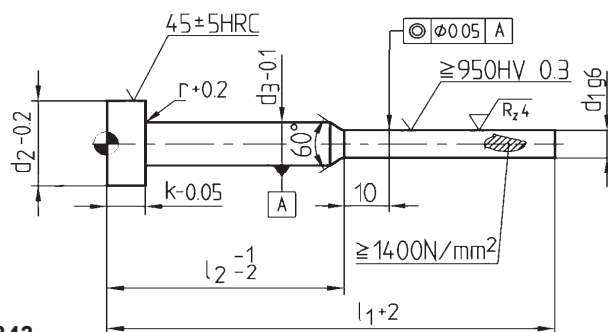

k	r	d <sub>3</sub>	d <sub>2</sub>	d <sub>1</sub>	l <sub>1</sub>	l <sub>2</sub>	€
2	0,2	2	4	0,8	80	50	6,68
					100	50	7,12
					125	50	7,55
					160	63	8,84
					200	80	10,24
2	0,2	2	4	0,9	80	50	6,68
					100	50	7,12
					125	50	7,55
					160	63	8,84
					200	80	10,24
2	0,2	2	4	1	80	50	6,68
					100	50	7,12
					125	50	7,55
					160	63	8,84
					200	80	10,24
2	0,2	2	4	1,1	80	50	6,68
					100	50	7,12
					125	50	7,55
					160	63	8,84
					200	80	10,24
2	0,2	2	4	1,2	80	50	6,68
					100	50	7,12
					125	50	7,55
					160	63	8,84
					200	80	10,24
2	0,2	2	4	1,3	80	50	6,68
					100	50	7,12
					125	50	7,55
					160	63	8,84
					200	80	10,24
2	0,2	2	4	1,4	80	50	6,68
					100	50	7,12
					125	50	7,55
					160	63	8,84
					200	80	10,24
3	0,3	3	6	1,5	80	50	5,71
					100	50	6,25
					125	50	6,68
					160	63	8,09
					200	80	9,49
3	0,3	3	6	1,6	80	50	5,71
					100	50	6,25
					125	50	6,68
					160	63	8,09
					200	80	9,49
3	0,3	3	6	1,7	80	50	5,71
					100	50	6,25
					125	50	6,68
					160	63	8,09
					200	80	9,49
3	0,3	3	6	1,8	80	50	5,71
					100	50	6,25
					125	50	6,68
					160	63	8,09
					200	80	9,49

d <sub>3</sub>	d <sub>2</sub>	k	l <sub>2</sub>	r	d <sub>1</sub>	l <sub>1</sub>	€
3	0,3	3	6	1,9	80	50	5,71
					100	50	6,25
					125	50	6,68
					160	63	8,09
					200	80	9,49
3	0,3	3	6	2	80	50	7,01
					100	50	7,55
					125	50	8,09
					160	63	9,16
					200	80	10,78
3	0,3	3	6	2,1	80	50	7,01
					100	50	7,55
					125	50	8,09
					160	63	9,16
					200	80	10,78
3	0,3	3	6	2,2	80	50	7,01
					100	50	7,55
					125	50	8,09
					160	63	9,16
					200	80	10,78
3	0,3	3	6	2,3	80	50	7,01
					100	50	7,55
					125	50	8,09
					160	63	9,16
					200	80	10,78
3	0,3	3	6	2,4	80	50	7,01
					100	50	7,55
					125	50	8,09
					160	63	9,16
					200	80	10,78
3	0,3	3	6	2,5	80	50	6,47
					100	50	7,01
					125	50	7,33
					160	63	8,62
					200	80	9,92
3	0,3	3	6	2,6	80	50	6,47
					100	50	7,01
					125	50	7,33
					160	63	8,62
					200	80	9,92
3	0,3	3	6	2,7	80	50	6,47
					100	50	7,01
					125	50	7,33
					160	63	8,62
					200	80	9,92
3	0,3	3	6	2,8	80	50	6,47
					100	50	7,01
					125	50	7,33
					160	63	8,62
					200	80	9,92
3	0,3	3	6	2,9	80	50	6,47
					100	50	7,01
					125	50	7,33
					160	63	8,62
					200	80	9,92

## KILA

Laposkilökö, edzett  
 Flachauswerfer, gehärtet  
 Flat ejector pin, hardened  
 DIN ISO 8693 (DIN 1530-4)

Rendelési példa: }  
 Bestell-Beispiel: } **KILA-axbxl<sub>1</sub>**  
 Order example: }

Anyag: }  
 Werkstoff: } **1.2516**  
 Material: }

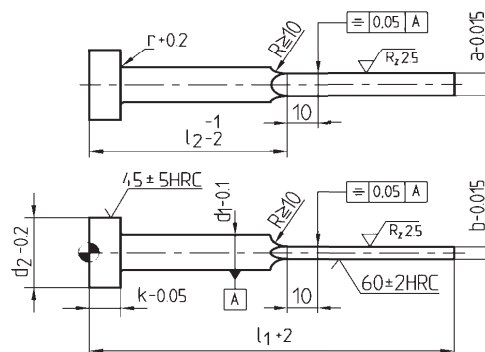

k	r	d <sub>1</sub>	d <sub>2</sub>	a	b	l <sub>1</sub>	l <sub>2</sub>	€
3	0,3	4,2	8	3,5	0,8	63	32	15,27
						80	40	15,27
						100	50	15,27
						125	63	19,73
						160	80	24,18
3	0,3	4,2	8	3,5	1	63	32	15,27
						80	40	15,27
						100	50	15,27
						125	63	19,73
						160	80	24,18
3	0,3	4,2	8	3,8	0,8	63	32	15,27
						80	40	15,27
						100	50	15,27
						125	63	19,73
						160	80	24,18
3	0,3	4,2	8	3,8	1	63	32	15,27
						80	40	15,27
						100	50	15,27
						125	63	19,73
						160	80	24,18
3	0,3	4,2	8	3,8	1,2	63	32	15,27
						80	40	15,27
						100	50	15,27
						125	63	19,73
						160	80	24,18
3	0,3	5	10	4,5	1	80	40	15,91
						100	50	15,91
						125	63	21,00
						160	80	24,18
3	0,3	5	10	4,5	1,2	80	40	15,91
						100	50	15,91
						125	63	21,00
						160	80	24,18
						200	100	31,18
3	0,3	5	10	4,5	1,5	80	40	15,91
						100	50	15,91
						125	63	21,00
						160	80	24,18
						200	100	31,18
5	0,5	6	12	5,5	1	80	40	17,18
						100	50	17,18
						125	63	22,27
						160	80	25,46
						200	100	31,82
5	0,5	6	12	5,5	1,2	80	40	17,18
						100	50	17,18
						125	63	22,27
						160	80	25,46
						200	100	31,82
5	0,5	6	12	5,5	1,5	80	40	17,18
						100	50	17,18
						125	63	22,27
						160	80	25,46
						200	100	31,82

k	r	d <sub>1</sub>	d <sub>2</sub>	a	b	l <sub>1</sub>	l <sub>2</sub>	€
5	0,5	6	12	5,5	1,5	125	63	22,27
						160	80	25,46
						200	100	31,82
						250	125	38,18
5	0,5	6	12	5,5	2	80	40	17,18
						100	50	17,18
						125	63	22,27
						160	80	25,46
						200	100	31,82
5	0,5	8	14	7,5	1,2	100	50	22,91
						125	63	28,00
						160	80	36,27
						200	100	45,18
						250	125	56,64
5	0,5	8	14	7,5	1,5	100	50	22,91
						125	63	28,00
						160	80	36,27
						200	100	45,18
						250	125	56,64
5	0,5	8	14	7,5	2	100	50	22,91
						125	63	28,00
						160	80	36,27
						200	100	45,18
						250	125	56,64
5	0,5	10	16	9,5	1,5	125	63	37,55
						160	80	47,73
						200	100	59,18
						250	125	75,09
						315	160	93,55
5	0,5	10	16	9,5	2	125	63	37,55
						160	80	47,73
						200	100	59,18
						250	125	75,09
						315	160	93,55
7	0,8	12	20	11,5	2	125	63	56,64
						160	80	71,02
						200	100	88,84
						250	125	111,37
						315	160	140,00
7	0,8	12	20	11,5	2,5	125	63	56,64
						160	80	71,02
						200	100	88,84
						250	125	111,37
						315	160	140,00
7	0,8	12	20	11,5	2,5	400	200	177,55
						125	63	56,64
						160	80	71,02
						200	100	88,84
						250	125	111,37

## KILA-R

Laposkilőkő, edzett, rádiusszal R 0,3  
 Flachauswerfer, gehärtet mit Radius R 0,3  
 Flat ejector pin, hardened with radius R 0,3  
 DIN ISO 8693 (DIN 1530-4)

Rendelési példa: }  
 Bestell-Beispiel: } **KILA-R-axbxl<sub>1</sub>**  
 Order example: }

Anyag: }  
 Werkstoff: } **1.2516**  
 Material: }

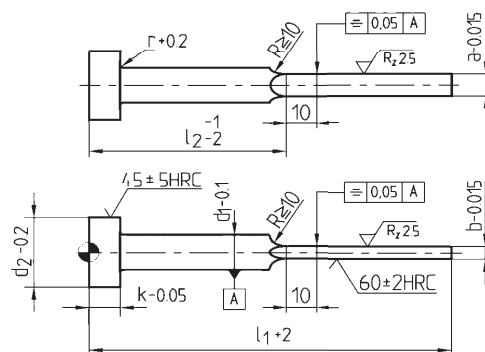

k	r	d <sub>1</sub>	d <sub>2</sub>	a	b	l <sub>1</sub>	l <sub>2</sub>	€
3	0,3	4,2	8	3,5	0,8	63	32	22,91
						80	40	22,91
						100	50	25,46
						125	63	28,00
						160	80	31,82
3	0,3	4,2	8	3,5	1	63	32	22,91
						80	40	22,91
						100	50	25,46
						125	63	28,00
						160	80	31,82
3	0,3	4,2	8	3,8	0,8	63	32	22,91
						80	40	22,91
						100	50	25,46
						125	63	28,00
						160	80	31,82
3	0,3	4,2	8	3,8	1	63	32	22,91
						80	40	22,91
						100	50	25,46
						125	63	28,00
						160	80	31,82
3	0,3	4,2	8	3,8	1,2	63	32	22,91
						80	40	22,91
						100	50	25,46
						125	63	28,00
						160	80	31,82
3	0,3	5	10	4,5	1	80	40	23,55
						100	50	26,73
						125	63	31,82
						160	80	31,82
						200	100	40,09
3	0,3	5	10	4,5	1,2	80	40	23,55
						100	50	26,73
						125	63	31,82
						160	80	31,82
						200	100	40,09
3	0,3	5	10	4,5	1,5	80	40	23,55
						100	50	26,73
						125	63	31,82
						160	80	31,82
						200	100	40,09
5	0,5	6	12	5,5	1	80	40	25,46
						100	50	28,00
						125	63	33,73
						160	80	36,27
						200	100	40,73
5	0,5	6	12	5,5	1,2	80	40	25,46
						100	50	28,00
						125	63	33,73
						160	80	36,27
						200	100	40,73
5	0,5	6	12	5,5	1,5	80	40	25,46
						100	50	28,00
						125	63	33,73
						160	80	36,27
						200	100	40,73

k	r	d <sub>1</sub>	d <sub>2</sub>	a	b	l <sub>1</sub>	l <sub>2</sub>	€
5	0,5	6	12	5,5	1,5	125	63	33,73
						160	80	36,27
						200	100	40,73
5	0,5	6	12	5,5	2	80	40	25,46
						100	50	28,00
						125	63	33,73
						200	100	40,73
						250	125	50,91
5	0,5	8	14	7,5	1,2	100	50	35,64
						125	63	44,55
						160	80	48,36
						200	100	57,27
						250	125	70,00
5	0,5	8	14	7,5	1,5	100	50	35,64
						125	63	44,55
						160	80	48,36
						200	100	57,27
						250	125	70,00
5	0,5	8	14	7,5	2	100	50	35,64
						125	63	44,55
						160	80	48,36
						200	100	57,27
						250	125	70,00
5	0,5	10	16	9,5	1,5	125	63	48,36
						160	80	57,27
						200	100	70,00
						250	125	82,73
						315	160	101,82
5	0,5	10	16	9,5	2	125	63	48,36
						160	80	57,27
						200	100	70,00
						250	125	82,73
						315	160	101,82
5	0,5	10	16	9,5	2	125	63	48,36
						160	80	57,27
						200	100	70,00
						250	125	82,73
						315	160	101,82
7	0,8	12	20	11,5	2	125	63	70,00
						160	80	82,73
						200	100	99,91
						250	125	120,91
						315	160	152,73
7	0,8	12	20	11,5	2,5	125	63	70,00
						160	80	82,73
						200	100	99,91
						250	125	120,91
						315	160	152,73
7	0,8	12	20	11,5	2,5	400	200	190,91
						250	125	120,91
						315	160	152,73

## KILN

Laposkilökö, nitridált  
 Flachauswerfer, nitriert  
 Flat ejector pin, nitrided  
 DIN ISO 8693 (DIN 1530-4)

Rendelési példa: }  
 Bestell-Beispiel: } **KILN-axbxl<sub>1</sub>**  
 Order example: }

Anyag: }  
 Werkstoff: } **1.2343**  
 Material: }

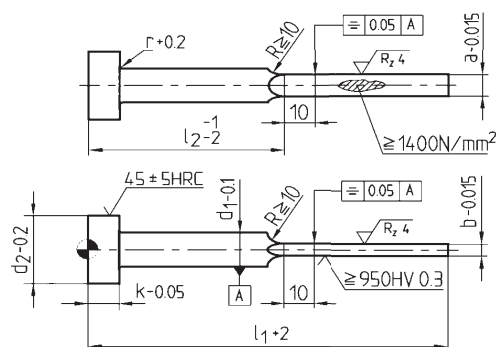

k	r	d <sub>1</sub>	d <sub>2</sub>	a	b	l <sub>1</sub>	l <sub>2</sub>	€
3	0,3	4,2	8	3,5	0,8	63	32	14,95
						80	40	14,95
						100	50	14,95
						125	63	18,77
						160	80	23,86
3	0,3	4,2	8	3,5	1	63	32	14,95
						80	40	14,95
						100	50	14,95
						125	63	18,77
						160	80	23,86
3	0,3	4,2	8	3,8	0,8	63	32	14,95
						80	40	14,95
						100	50	14,95
						125	63	18,77
						160	80	23,86
3	0,3	4,2	8	3,8	1	63	32	14,95
						80	40	14,95
						100	50	14,95
						125	63	18,77
						160	80	23,86
3	0,3	4,2	8	3,8	1,2	63	32	14,95
						80	40	14,95
						100	50	14,95
						125	63	18,77
						160	80	23,86
3	0,3	5	10	4,5	1	80	40	14,95
						100	50	14,95
						125	63	10,50
						160	80	23,86
3	0,3	5	10	4,5	1,2	80	40	14,95
						100	50	14,95
						125	63	10,50
						160	80	23,86
						200	100	29,59
3	0,3	5	10	4,5	1,5	80	40	14,95
						100	50	14,95
						125	63	10,50
						160	80	23,86
						200	100	29,59
5	0,5	6	12	5,5	1	80	40	14,95
						100	50	14,95
						125	63	11,14
						160	80	23,86
						200	100	29,59
5	0,5	6	12	5,5	1,2	80	40	14,95
						100	50	14,95
						125	63	11,14
						160	80	23,86
						200	100	29,59
5	0,5	6	12	5,5	1,5	80	40	14,95
						100	50	14,95
						125	63	11,14
						160	80	23,86
						200	100	29,59

k	r	d <sub>1</sub>	d <sub>2</sub>	a	b	l <sub>1</sub>	l <sub>2</sub>	€
5	0,5	6	12	5,5	1,5	125	63	11,14
						160	80	23,86
						200	100	29,59
5	0,5	6	12	5,5	2	80	40	14,95
						100	50	14,95
						125	63	11,14
						200	100	29,59
						250	125	37,23
5	0,5	8	14	7,5	1,2	100	50	22,91
						125	63	28,96
						160	80	35,51
						200	100	44,42
						250	125	55,49
5	0,5	8	14	7,5	1,5	100	50	22,91
						125	63	28,96
						160	80	35,51
						200	100	44,42
						250	125	55,49
5	0,5	8	14	7,5	2	100	50	22,91
						125	63	28,96
						160	80	35,51
						200	100	44,42
						250	125	55,49
5	0,5	10	16	9,5	1,5	125	63	33,28
						160	80	42,64
						200	100	53,26
						250	125	66,63
						315	160	83,94
5	0,5	10	16	9,5	2	125	63	33,28
						160	80	42,64
						200	100	53,26
						250	125	66,63
						315	160	83,94
7	0,8	12	20	11,5	2	125	63	44,42
						160	80	56,83
						200	100	71,02
						250	125	88,77
						315	160	111,87
7	0,8	12	20	11,5	2,5	125	63	44,42
						160	80	56,83
						200	100	71,02
						250	125	88,77
						315	160	111,87
7	0,8	12	20	11,5	2,5	400	200	142,23
						400	200	142,23

## KILN

Laposkilőkő, nitridált  
 Flachauswerfer, nitriert  
 Flat ejector pin, nitrided  
 DIN ISO 8693 (DIN 1530-4)

Rendelési példa: }  
 Bestell-Beispiel: } **KILN-axbxl<sub>1</sub>**  
 Order example: }

Anyag: }  
 Werkstoff: } **1.2343**  
 Material: }

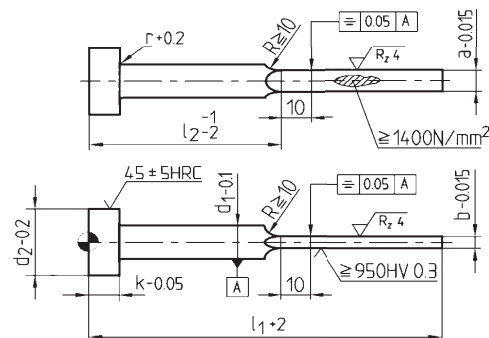

k	r	d <sub>1</sub>	d <sub>2</sub>	a	b	l <sub>1</sub>	l <sub>2</sub>	€
3	0,3	4,2	8	3,5	0,8	63	32	14,95
						80	40	14,95
						100	50	14,95
						125	63	18,77
						160	80	23,86
3	0,3	4,2	8	3,5	1	63	32	14,95
						80	40	14,95
						100	50	14,95
						125	63	18,77
						160	80	23,86
3	0,3	4,2	8	3,8	0,8	63	32	14,95
						80	40	14,95
						100	50	14,95
						125	63	18,77
						160	80	23,86
3	0,3	4,2	8	3,8	1	63	32	14,95
						80	40	14,95
						100	50	14,95
						125	63	18,77
						160	80	23,86
3	0,3	4,2	8	3,8	1,2	63	32	14,95
						80	40	14,95
						100	50	14,95
						125	63	18,77
						160	80	23,86
3	0,3	5	10	4,5	1	80	40	14,95
						100	50	14,95
						125	63	10,50
						160	80	23,86
						3	0,3	5
100	50	14,95						
125	63	10,50						
160	80	23,86						
200	100	29,59						
3	0,3	5	10	4,5	1,5	80	40	14,95
						100	50	14,95
						125	63	10,50
						160	80	23,86
						200	100	29,59
5	0,5	6	12	5,5	1	80	40	14,95
						100	50	14,95
						125	63	11,14
						160	80	23,86
						200	100	29,59
5	0,5	6	12	5,5	1,2	80	40	14,95
						100	50	14,95
						125	63	11,14
						160	80	23,86
						200	100	29,59
5	0,5	6	12	5,5	1,5	80	40	14,95
						100	50	14,95
						125	63	11,14
						160	80	23,86
						100	50	14,95

k	r	d <sub>1</sub>	d <sub>2</sub>	a	b	l <sub>1</sub>	l <sub>2</sub>	€
5	0,5	6	12	5,5	1,5	125	63	11,14
						160	80	23,86
						200	100	29,59
5	0,5	6	12	5,5	2	80	40	14,95
						100	50	14,95
						125	63	11,14
						160	80	23,86
						200	100	29,59
5	0,5	8	14	7,5	1,2	250	125	37,23
						100	50	22,91
						125	63	28,96
5	0,5	8	14	7,5	1,5	100	50	22,91
						125	63	28,96
						160	80	35,51
						200	100	44,42
						250	125	55,49
5	0,5	8	14	7,5	2	315	160	69,94
						100	50	22,91
						125	63	28,96
						160	80	35,51
						200	100	44,42
5	0,5	8	14	7,5	2	250	125	55,49
						315	160	69,94
						100	50	22,91
						125	63	28,96
						160	80	35,51
5	0,5	10	16	9,5	1,5	125	63	33,28
						160	80	42,64
						200	100	53,26
						250	125	66,63
						315	160	83,94
5	0,5	10	16	9,5	2	400	200	106,53
						125	63	33,28
						160	80	42,64
						200	100	53,26
						250	125	66,63
5	0,5	10	16	9,5	2	315	160	83,94
						400	200	106,53
						125	63	33,28
						160	80	42,64
						200	100	53,26
7	0,8	12	20	11,5	2	125	63	44,42
						160	80	56,83
						200	100	71,02
						250	125	88,77
						315	160	111,87
7	0,8	12	20	11,5	2,5	400	200	142,23
						125	63	44,42
						160	80	56,83
						200	100	71,02
						250	125	88,77
7	0,8	12	20	11,5	2,5	315	160	111,87
						400	200	142,23
						125	63	44,42
						160	80	56,83
						200	100	71,02

## KICA

**Csőkilökő, edzett**  
**Auswerferhülse, gehärtet**  
**Ejector sleeve, hardened**  
**DIN ISO 8405 (DIN 16756)**

Rendelési példa: }  
 Bestell-Beispiel: } **KICA-d<sub>1</sub>xb<sub>1</sub>xl<sub>1</sub>**  
 Order example: }

Anyag: }  
 Werkstoff: } **1.2516**  
 Material: }

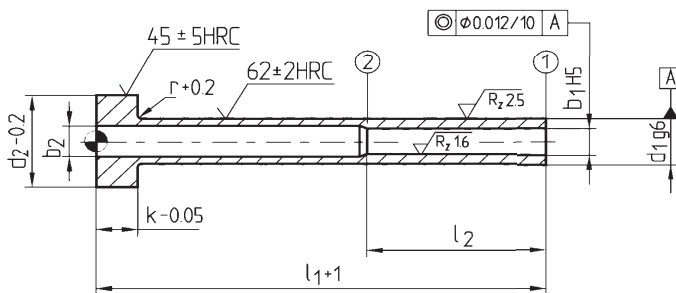

k	r	b <sub>2</sub>	d <sub>2</sub>	d <sub>1</sub>	b <sub>1</sub>	l <sub>1</sub>	l <sub>2</sub>	€
3	0,3	2,5	8	4	2	75	35	15,58
						100		20,16
						125		24,28
						150		29,32
						175		35,28
						200		39,86
						250		50,86
3	0,3	2,5	8	4	2,2	75	35	15,58
						100		20,16
						125		24,28
						150		29,32
						175		35,28
						200		39,86
						250		50,86
3	0,3	3	10	5	2,5	75	35	15,58
						100		20,16
						125		24,28
						150		29,32
						175		35,28
						200		39,86
						250		50,86
3	0,3	3	10	5	2,7	75	35	15,58
						100		20,16
						125		24,28
						150		29,32
						175		35,28
						200		39,86
						250		50,86
3	0,3	3,5	10	5	3	75	45	15,58
						100		20,16
						125		24,28
						150		29,32
						175		35,28
						200		39,86
						250		50,86
3	0,3	3,5	10	5	3,2	75	45	15,58
						100		20,16
						125		24,28
						150		29,32
						175		35,28
						200		39,86
						250		50,86
300	61,58							

k	r	b <sub>2</sub>	d <sub>2</sub>	d <sub>1</sub>	b <sub>1</sub>	l <sub>1</sub>	l <sub>2</sub>	€
5	0,5	4	12	6	3,5	75	45	15,58
						100		20,16
						125		24,28
						150		29,32
						175		35,28
						200		39,86
						250		50,86
5	0,5	4	12	6	3,7	75	45	15,58
						100		20,16
						125		24,28
						150		29,32
						175		35,28
						200		39,86
						250		50,86
5	0,5	4,5	12	6	4	75	45	15,58
						100		20,16
						125		24,28
						150		29,32
						175		35,28
						200		39,86
						250		50,86
5	0,5	4,5	14	8	4,2	75	45	16,68
						100		21,53
						125		27,49
						150		32,07
						175		38,03
						200		41,79
						250		54,98
5	0,5	4,5	14	8	5	75	45	16,68
						100		21,53
						125		27,49
						150		32,07
						175		38,03
						200		41,79
						250		54,98
300	64,15							
500	100,80							

## KICA

**Csőkilökő, edzett**  
**Auswerferhülse, gehärtet**  
**Ejector sleeve, hardened**  
**DIN ISO 8405 (DIN 16756)**

Rendelési példa: }  
 Bestell-Beispiel: } **KICA-d<sub>1</sub>x**b<sub>1</sub>**,xl<sub>1</sub>  
 Order example: }**

Anyag: }  
 Werkstoff: } **1.2516**  
 Material: }

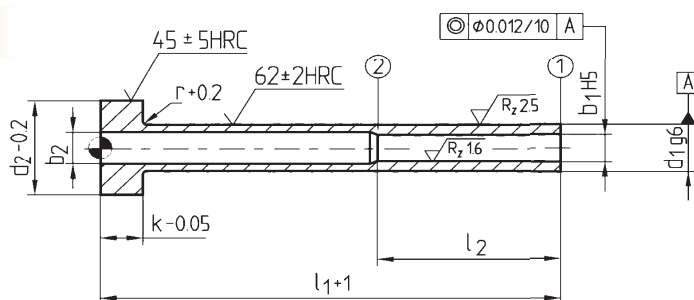

k	r	b <sub>2</sub>	d <sub>2</sub>	d <sub>1</sub>	b <sub>1</sub>	l <sub>1</sub>	l <sub>2</sub>	€
5	0,5	5,5	14	8	5,2	75	45	16,68
								100
								125
								150
								175
								200
								250
								300
								500
5	0,5	6,5	16	10	6	75	45	18,33
								100
								125
								150
								175
								200
								250
								300
								500
5	0,5	6,5	16	10	6,2	75	45	18,33
								100
								125
								150
								175
								200
								250
								300
								500
7	0,8	8,5	20	12	8	75	45	20,16
								100
								125
								150
								175
								200
								250
								300
								500

k	r	b <sub>2</sub>	d <sub>2</sub>	d <sub>1</sub>	b <sub>1</sub>	l <sub>1</sub>	l <sub>2</sub>	€								
7	0,8	8,5	20	12	8,2	75	45	20,16								
								100								
								125								
								150								
								175								
								200								
								250								
								300								
								500								
7	0,8	10,5	22	14	10	125	45	45,82								
								150								
								175								
								200								
								250								
								300								
								500								
								7	0,8	11	22	14	10,5	125	45	45,82
																150
175																
200																
250																
300																
500																
7	0,8	12,5	22	16	12	125	45									45,82
																150
								175								
								200								
								250								
								300								
								500								
								7	0,8	13	22	16	12,5	125	45	45,82
																150
175																
200																
250																
300																
500																

## KICN

**Csőkilövő, nitridált, eloxált**  
**Auswerferhülse, nitriert, oxidiert**  
**Ejector sleeve, nitrided and oxidized**  
**DIN ISO 8405 (DIN 16756)**

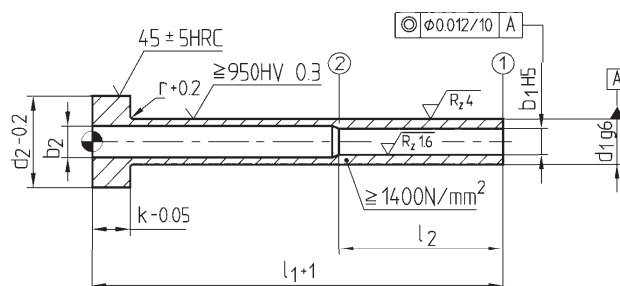

Rendelési példa: }  
 Bestell-Beispiel: } **KICN-d<sub>1</sub>x**b<sub>1</sub>**,**x**l<sub>1</sub>  
 Order example: }**

Anyag: }  
 Werkstoff: } **1.2343**  
 Material: }

Z 45

k	r	b <sub>2</sub>	d <sub>2</sub>	d <sub>1</sub>	b <sub>1</sub>	l <sub>1</sub>	l <sub>2</sub>	€
3	0,3	2,5	8	4	2	75	35	18,69
						100		24,19
						125		29,14
						150		35,19
						175		42,34
						200		47,84
250	61,03							
3	0,3	2,5	8	4	2,2	75	35	18,69
						100		24,19
						125		29,14
						150		35,19
						175		42,34
						200		47,84
250	61,03							
3	0,3	3	10	5	2,5	75	35	18,69
						100		24,19
						125		29,14
						150		35,19
						175		42,34
						200		47,84
250	61,03							
300	73,90							
3	0,3	3	10	5	2,7	75	35	18,69
						100		24,19
						125		29,14
						150		35,19
						175		42,34
						200		47,84
250	61,03							
300	73,90							
3	0,3	3,5	10	5	3	75	45	18,69
						100		24,19
						125		29,14
						150		35,19
						175		42,34
						200		47,84
250	61,03							
300	73,90							
3	0,3	3,5	10	5	3,2	75	45	18,69
						100		24,19
						125		29,14
						150		35,19
						175		42,34
						200		47,84
250	61,03							
300	73,90							

k	r	b <sub>2</sub>	d <sub>2</sub>	d <sub>1</sub>	b <sub>1</sub>	l <sub>1</sub>	l <sub>2</sub>	€
5	0,5	4	12	6	3,5	75	45	18,69
						100		24,19
						125		29,14
						150		35,19
						175		42,34
						200		47,84
250	61,03							
300	73,90							
5	0,5	4	12	6	3,7	75	45	18,69
						100		24,19
						125		29,14
						150		35,19
						175		42,34
						200		47,84
250	61,03							
300	73,90							
5	0,5	4,5	12	6	4	75	45	18,69
						100		24,19
						125		29,14
						150		35,19
						175		42,34
						200		47,84
250	61,03							
300	73,90							
5	0,5	4,5	14	8	4,2	75	45	20,01
						100		25,84
						125		32,99
						150		38,49
						175		45,64
						200		50,14
250	65,98							
300	76,98							
5	0,5	5,5	14	8	5	75	45	20,01
						100		25,84
						125		32,99
						150		38,49
						175		45,64
						200		50,14
250	65,98							
300	76,98							
500	120,96							



## KICN

**Csőkilövő, nitridált, eloxált**  
**Auswerferhülse, nitriert, oxidiert**  
**Ejector sleeve, nitrided and oxidized**  
**DIN ISO 8405 (DIN 16756)**

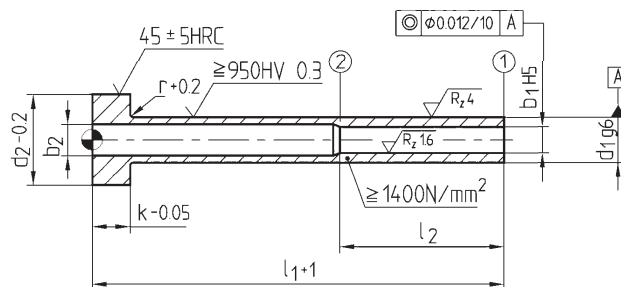

Rendelési példa: }  
 Bestell-Beispiel: } **KICN-d<sub>1</sub>x<sub>b</sub><sub>1</sub>x<sub>l<sub>1</sub></sub>**  
 Order example: }

Anyag: }  
 Werkstoff: } **1.2343**  
 Material: }

k	r	b <sub>2</sub>	d <sub>2</sub>	d <sub>1</sub>	b <sub>1</sub>	l <sub>1</sub>	l <sub>2</sub>	€
5	0,5	5,5	14	8	5,2	75	45	20,01
								100
								125
								150
								175
								200
								250
								300
5	0,5	6,5	16	10	6	75	45	21,99
								100
								125
								150
								175
								200
								250
								300
5	0,5	6,5	16	10	6,2	75	45	21,99
								100
								125
								150
								175
								200
								250
								300
7	0,8	8,5	20	12	8	75	45	24,19
								100
								125
								150
								175
								200
								250
								300
7	0,8	8,5	20	12	8	100	45	30,79
								125
								150
								175
								200
								250
								300
								500

k	r	b <sub>2</sub>	d <sub>2</sub>	d <sub>1</sub>	b <sub>1</sub>	l <sub>1</sub>	l <sub>2</sub>	€
7	0,8	8,5	20	12	8,2	75	45	24,19
								100
								125
								150
								175
								200
								250
								300
7	0,8	10,5	22	14	10	125	45	54,98
								150
								175
								200
								250
								300
								500
								7
150								
175								
200								
250								
300								
500								
7	0,8	12,5	22	16	12	125	45	
								150
								175
								200
								250
								300
								500
								7
150								
175								
200								
250								
300								
500								

**BÜTTNER**  
NORMÁLIA KFT.



Büttner Normália Kft. H-7500 Nagyatád, Taranyi út, Ipartelep

Tel.: 00 36 82 553 970; 553 971; Fax: 00 36 82 553 981

E-mail: [buttner@hu.inter.net](mailto:buttner@hu.inter.net)

[www.buttner.hu](http://www.buttner.hu)

**Ejector pins**



**BÜTTNER**  
& Co.



Büttner & Co. H-7500 Nagyatád, Taranyi út, Ipartelep

Tel.: 00 36 82 553 970; 553 971; Fax: 00 36 82 553 981

E-mail: [buttner@hu.inter.net](mailto:buttner@hu.inter.net)

[www.buttner.hu](http://www.buttner.hu)

**BÜTTNER**  
MOULD PARTS



Büttner Mould Parts 535600 Odorheiu Secuiesc, Str. Vulturului nr. 2/a

Tel.: +40 266 206 192; Tel./fax: +40 266 216 164

E-mail: [office@buttner.ro](mailto:office@buttner.ro)

[www.buttner.ro](http://www.buttner.ro)