

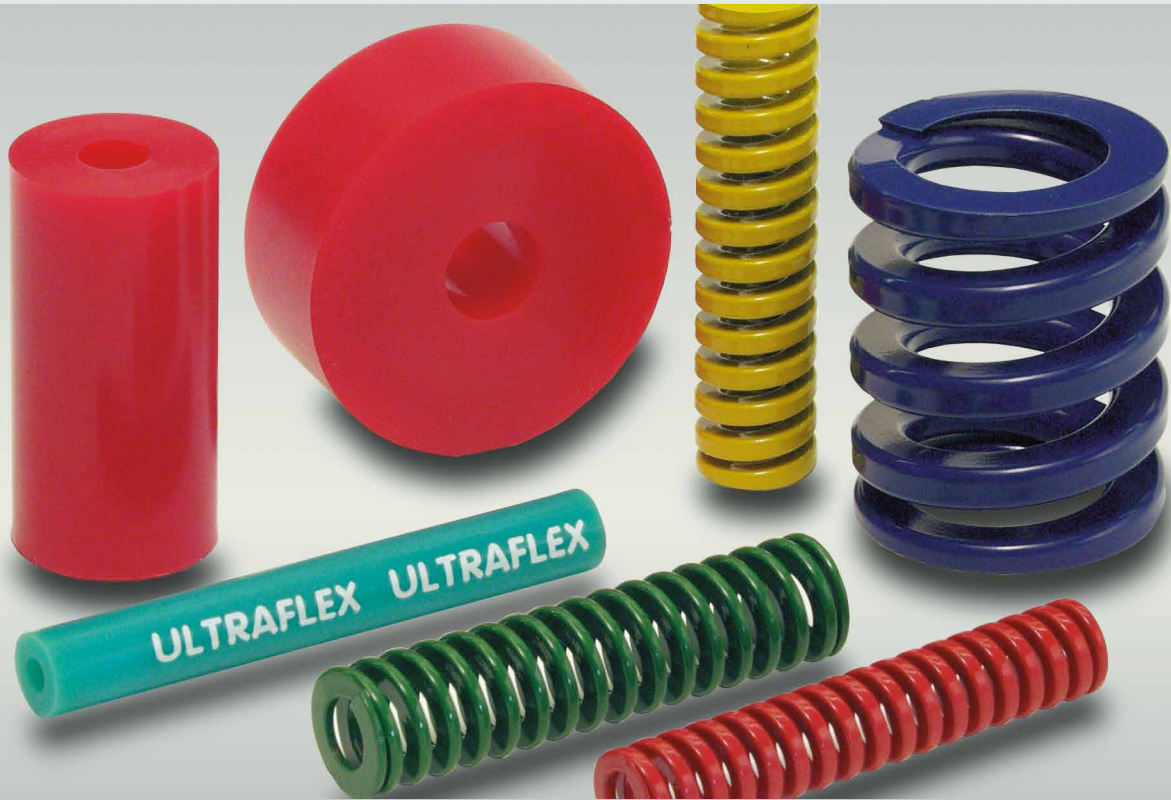





MSP **N** **G**
M **B** **H**





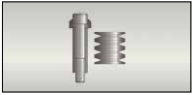



Märkische Stanz-Partner







[federelemente]

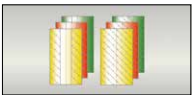

[springs]

	Tellerfedern, Distanzeinheiten	Disk washers, spacers	Best.-Nr. Order no.	Seite Page
	<u>Distanzeinheiten, geschliffen</u>	<u>Spacers, ground</u>	FE 830	FE.2
	<u>Distanzrohre, geschliffen</u>	<u>Spacer tubes, ground</u>	FE 829	FE.3
	<u>Scheiben für Zylinderschraube, nicht geschliffen</u>	<u>Disks for hexagon socket head cap screw, not ground</u>	FE 828	FE.3
	<u>Tellerfedern DIN 2093</u>	<u>Disk springs DIN 2093</u>	FE 850	FE.1

	Systemfedern	Compression springs	Best.-Nr. Order no.	Seite Page
	<u>Systemfedern ISO 10243, Kennfarbe Grün: Leichte Belastung</u>	<u>Compression springs, ISO 10243 Color code green: light load springs</u>	FE 831 LB	FE.4 FE.5
	<u>Systemfedern ISO 10243, Kennfarbe Blau: Mittlere Belastung</u>	<u>Compression springs, ISO 10243 Color code blue: medium load springs</u>	FE 832 MB	FE.6 FE.7
	<u>Systemfedern ISO 10243, Kennfarbe Rot: Schwere Belastung</u>	<u>Compression springs, ISO 10243 Color code red: heavy load springs</u>	FE 833 SB	FE.8 FE.9
	<u>Systemfedern ISO 10243, Kennfarbe Gelb: Bes. schw. Belastung</u>	<u>Compression springs, ISO 10243 Color code yellow: extra h. load springs</u>	FE 834 BB	FE.10 FE.11
	<u>Systemfedern nach US-Farbcodierung, Kennfarbe Blau: Leichte Belastung</u>	<u>Compression springs, US color coded Color code blue: light load springs</u>	FE 835 LB	FE.12 FE.13
	<u>Systemfedern nach US-Farbcodierung, Kennfarbe Rot: Mittlere Belastung</u>	<u>Compression springs, US color coded Color code red: medium load springs</u>	FE 836 MB	FE.14 FE.15
	<u>Systemfedern nach US-Farbcodierung, Kennfarbe Gold: Schwere Belastung</u>	<u>Compression springs, US color coded Color code gold: heavy load springs</u>	FE 837 SB	FE.16 FE.17
	<u>Systemfedern nach US-Farbcodierung, Kennfarbe Grün: Bes. schw. Belastung</u>	<u>Compression springs, US color coded Color code green: extra h. load springs</u>	FE 838 BB	FE.18 FE.19

	Urelastfedern	Elastomer springs	Best.-Nr. Order no.	Seite Page
	<u>Hohlstangen</u>	<u>Hollow bars</u>	FE 804, FE 805, FE 806	FE.21
	<u>Urelastfedern DIN 9835, Kennfarbe Rot</u>	<u>Elastomer springs DIN 9835, color code red</u>	FE 802	FE.20
	<u>Vollstangen</u>	<u>Solid bars</u>	FE 807, FE 808, FE 809	FE.23

[FE]

	Zubehör Bereich Federelemente	Accessories product line „springs“	Best.-Nr. Order no.	Seite Page
	<u>Federteller DIN ISO 10069-2 für Urelastfedern</u>	<u>Spring washers. DIN ISO 10069-2 for elastomer-springs</u>	FE 815	FE.22
	<u>Führungsbolzen für Urelastfedern</u>	<u>Guide pins for elastomer springs</u>	FE 816	FE.22

FE 850

Mat. bis t = 1,1: CK 67
Mat. ab t = 1,25: 50CrV4

Mat. up to t = 1,1: CK 67
Mat. from t = 1,25: 50CrV4

FE 850 /
8,0 x 4,2 x 0,40

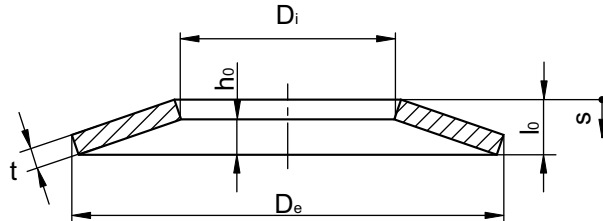

De	Di	t	lo	ho	s = 0,25 x ho			s = 0,5 x ho			s = 0,75 x ho		
					s	F N	σ N/mm ²	s	F N	σ N/mm ²	s	F N	σ N/mm ²
8,0	3,2	0,40	0,60	0,20	0,050	69,2	797	0,100	130,1	1533	0,150	185,5	2207
8,0	4,2	0,40	0,60	0,20	0,050	78,2	784	0,100	147,1	1504	0,150	209,5	2162
10,0	5,2	0,40	0,70	0,30	0,075	87,8	857	0,150	155,3	1623	0,225	209,3	2299
10,0	5,2	0,50	0,75	0,25	0,062	121,5	782	0,125	228,3	1502	0,187	325,3	2159
12,0	6,2	0,50	0,85	0,35	0,087	133,5	845	0,175	239,2	1605	0,262	326,4	2280
12,5	6,2	0,70	1,00	0,30	0,075	239,4	804	0,150	456,8	1550	0,225	659,5	2240
14,0	7,2	0,80	1,10	0,30	0,075	283,8	712	0,150	547,2	1377	0,225	796,8	1997
15,0	5,2	0,70	1,25	0,55	0,137	340,2	1317	0,275	596,4	2497	0,412	796,5	3541
16,0	8,2	0,60	1,05	0,45	0,112	172,0	751	0,225	304,3	1423	0,337	410,0	2016
16,0	8,2	0,90	1,25	0,35	0,087	362,5	721	0,175	697,0	1394	0,262	1013,0	2019
18,0	9,2	1,00	1,40	0,40	0,100	450,6	728	0,200	865,0	1406	0,300	1254,0	2035
20,0	10,2	0,80	1,35	0,55	0,137	304,3	759	0,275	546,8	1442	0,412	748,2	2050
20,0	10,2	0,90	1,45	0,55	0,137	411,7	821	0,275	754,0	1566	0,412	1050,0	2235
20,0	10,2	1,00	1,55	0,55	0,137	543,6	882	0,275	1010,0	1689	0,412	1425,0	2421
20,0	10,2	1,10	1,55	0,45	0,112	548,2	733	0,225	1050,0	1416	0,337	1521,0	2048
23,0	12,2	1,25	1,85	0,60	0,150	863,4	881	0,300	1630,0	1692	0,450	2331,0	2436
25,0	12,2	0,90	1,60	0,70	0,175	366,8	724	0,350	644,3	1371	0,525	862,3	1940
25,0	12,2	1,50	2,05	0,55	0,137	1040,0	761	0,275	2007,0	1473	0,412	2926,0	2138
28,0	14,2	1,00	1,80	0,80	0,200	476,4	744	0,400	832,0	1406	0,600	1107,0	1986
28,0	14,2	1,50	2,15	0,65	0,162	1033,0	747	0,325	1970,0	1440	0,487	2841,0	2080
31,5	16,3	1,25	2,15	0,90	0,225	790,5	797	0,450	1409,0	1512	0,675	1913,0	2145
31,5	16,3	1,75	2,45	0,70	0,175	1391,0	729	0,350	2669,0	1408	0,525	3871,0	2038
34,0	12,3	1,25	2,45	1,20	0,300	946,4	1063	0,600	1587,0	2001	0,900	2024,0	2814
35,5	18,3	2,00	2,80	0,80	0,200	1864,0	749	0,400	3576,0	1448	0,600	5187,0	2095
40,0	14,3	1,50	2,80	1,30	0,325	1188,0	962	0,650	2040,0	1818	0,975	2668,0	2568
40,0	20,4	2,25	3,15	0,90	0,225	2336,0	746	0,450	4481,0	1441	0,675	6500,0	2086
45,0	22,4	2,50	3,50	1,00	0,250	2773,0	726	0,500	5320,0	1403	0,750	7716,0	2031
50,0	18,4	1,50	3,15	1,65	0,412	1166,0	855	0,825	1890,0	1602	1,237	2319,0	2239
50,0	25,4	2,50	3,90	1,40	0,350	3473,0	903	0,700	6437,0	1728	1,050	9063,0	2474
50,0	25,4	3,00	4,10	1,10	0,275	4255,0	762	0,550	8214,0	1476	0,825	11976,0	2142
56,0	28,5	2,00	3,60	1,60	0,400	1910,0	744	0,800	3335,0	1406	1,200	4438,0	1987
60,0	20,5	2,00	4,20	2,20	0,550	2528,0	1082	1,100	4097,0	2028	1,650	5026,0	2837
70,0	30,5	2,50	4,90	2,40	0,600	3755,0	961	1,200	6297,0	1807	1,800	8031,0	2538
80,0	36,0	3,00	5,70	2,70	0,675	5401,0	964	1,350	9196,0	1817	2,025	11919,0	2557

s = Federweg/ Spring deflection, F = Federkraft/ Spring force, σ = Federspannung/ Spring tension

[FE]



FE 830

Mat.: Einsatzstahl
Festigkeitsklasse 12.9

Mat.: case-hardened steel
Property class 12.9

FE 830 / 15,0 x 50

- Lieferumfang:
1. Distanzrohr
Mat.: Vergütungsstahl, geschliffen
Festigkeit: 120 - 140 kg/mm²
 2. Scheibe für Zylinderkopfschraube
Mat.: Vergütungsstahl, nicht geschliffen
Festigkeit: 100 kg/mm²
 3. Zylinderschraube mit Innensechskant

- Included:
1. Spacer tube
Mat.: quenched and tempered steel, ground
Tensile strength: 120 - 140 kg/mm²
 2. Disk for cylinder head screw
Mat.: quenched and tempered steel, not ground
Tensile strength: 100 kg/mm²
 3. Hexagon socket head cap screw

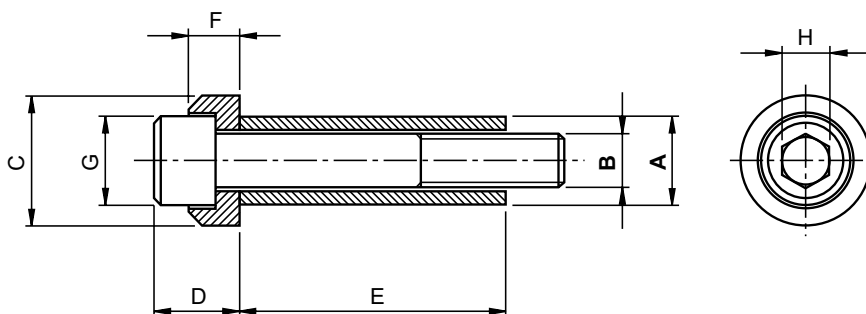

A	B	C	D	F	G	H	E +0,1																	
							20	25	30	35	40	45	50	55	60	70	80	90	100	110	120	140	150	160
10,0	M6	15	10	5,5	10	5	•	•	•	•	•	•	•	•	•	•	•							
12,5	M8	19	13	6,5	13	6			•	•	•	•	•	•	•	•	•							
15,0	M10	23	15	7,5	16	8			•	•	•	•	•	•	•	•	•							
17,5	M12	27	18	9,0	18	10				•	•	•	•	•	•	•	•	•	•	•				
23,0	M16	34	24	11,0	24	14						•	•	•	•	•	•	•	•	•	•	•	•	•



Scheiben für Zylinderschraube, nicht geschliffen

Disks for hex. socket head cap screws, not ground



FEDERELEMENTE / SPRINGS

FE 828

Mat.: Vergütungsstahl,
nicht geschliffen
Festigkeit: 100 kg/mm²

Mat.: Quenched and temper steel,
not ground
Tensile strength: 100 kg/mm²

FE 828 / 6,5

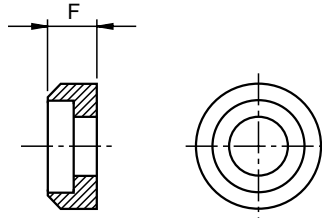

für Zylinderschrauben mit Innensechskant TH 110 for socket head cap screws TH 110 siehe Seite/ please see page TH.4	F ±0,2
M6	5,5
M8	6,5
M10	7,5
M12	9,0
M16	11,0

Distanzrohr, geschliffen

Spacer tubes, ground

FE 829

Mat.: Vergütungsstahl,
geschliffen
Festigkeit: 120 - 140 kg/mm²

Mat.: Quenched and temper steel,
ground
Tensile strength: 120 - 140 kg/mm²

FE 829 / 12,5 x 50

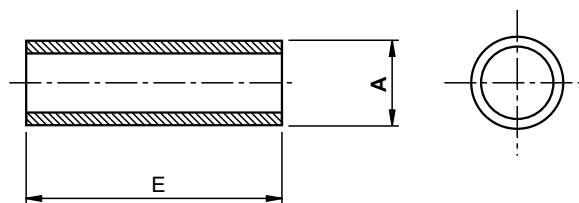

A h7	E +0,1																		
	20	25	30	35	40	45	50	55	60	70	80	90	100	110	120	140	150	160	
10,0	•	•	•	•	•	•	•	•	•	•	•	•	•						
12,5			•	•	•	•	•	•	•	•	•	•	•						
15,0			•	•	•	•	•	•	•	•	•	•	•		•				
17,5					•	•	•	•	•	•	•	•	•	•	•	•			
23,0							•		•	•	•	•	•	•	•	•	•		



[FE]

FE 831 LB

FE 831 LB / 10 x 025

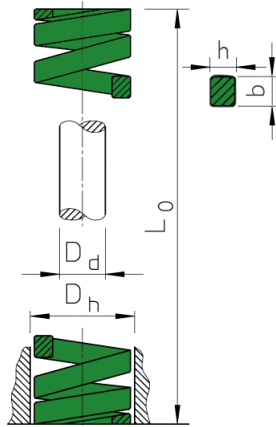

Dh mm	Lo mm	b mm	h mm	Dd mm	C N/mm	25% Arbeitsweg Working stroke		30% Arbeitsweg Working stroke		40% Arbeitsweg Working stroke		max. Federweg max. deflection mm
						mm	N	mm	N	mm	N	
10	025	1,7	1,1	5,0	10,0	6,3	63	7,5	75	10,0	100	13,5
	032				8,5	8,0	68	9,6	82	12,8	109	17,5
	038				6,8	9,5	65	11,4	78	15,2	103	20,8
	044				6,0	11,0	66	13,2	79	17,6	106	23,9
	051				5,0	12,8	64	15,3	77	20,4	102	28,9
	064				4,3	16,0	69	19,2	83	25,6	110	36,1
	076				3,2	19,0	61	22,8	73	30,4	97	43,2
	305				1,1	76,3	84	91,5	101	122,0	134	178,0
13	025	2,4	1,4	6,3	17,9	6,3	113	7,5	134	10,0	179	13,2
	032				16,4	8,0	131	9,6	157	12,8	210	18,0
	038				13,6	9,5	129	11,4	155	15,2	207	21,0
	044				12,1	11,0	133	13,2	160	17,6	213	24,0
	051				11,4	12,8	146	15,3	174	20,4	233	28,7
	064				9,3	16,0	149	19,2	179	25,6	238	35,8
	076				7,1	19,0	135	22,8	162	30,4	216	42,7
	089				5,4	22,3	120	26,7	144	35,6	192	50,4
	102				4,1	25,5	105	30,6	125	40,8	167	58,4
	305				1,4	76,3	107	91,5	128	122,0	171	172,0
	16				025	3,2	1,5	8,0	23,4	6,3	147	7,5
032		22,9	8,0	183	9,6				220	12,8	293	16,4
038		19,3	9,5	183	11,4				220	15,2	293	19,7
044		17,1	11,0	188	13,2				226	17,6	301	22,5
051		15,7	12,8	201	15,3				240	20,4	320	26,3
064		10,7	16,0	171	19,2				205	25,6	274	33,3
076		10,0	19,0	190	22,8				228	30,4	304	40,2
089		8,6	22,3	192	26,7				230	35,6	306	47,6
102		7,8	25,5	199	30,6				239	40,8	318	55,4
115		6,6	28,8	190	34,5				228	46,0	304	60,8
305		2,5	76,3	191	91,5				229	122,0	305	165,0
20		025	4,0	2,1	10,0				55,8	6,3	352	7,5
	032	45,0				8,0	360	9,6	432	12,8	576	15,3
	038	33,3				9,5	316	11,4	380	15,2	506	18,9
	044	30,0				11,0	330	13,2	396	17,6	528	21,5
	051	24,5				12,8	314	15,3	375	20,4	500	25,0
	064	20,0				16,0	320	19,2	384	25,6	512	31,1
	076	16,0				19,0	304	22,8	365	30,4	486	37,3
	089	14,0				22,3	312	26,7	374	35,6	498	44,5
	102	12,0				25,5	306	30,6	367	40,8	490	51,1
	115	10,9				28,8	314	34,5	376	46,0	501	58,2
	127	9,5				31,8	302	38,1	362	50,8	483	64,9
	139	8,5				34,8	294	41,7	353	55,6	470	71,5
	152	7,5				38,0	285	45,6	342	60,8	456	78,8
	305	4,0				76,3	305	91,5	366	122,0	488	157,0
25	025	5,4	2,7	12,5	100,0	6,3	630	7,5	750	10,0	1000	11,9
	032				80,3	8,0	642	9,6	771	12,8	1028	16,0
	038				62,0	9,5	589	11,4	707	15,2	942	18,3
	044				52,9	11,0	582	13,2	698	17,6	931	21,4
	051				44,0	12,8	563	15,3	673	20,4	898	24,9
	064				35,2	16,0	563	19,2	676	25,6	901	31,4



Dh mm	L0 mm	b mm	h mm	Dd mm	C N/mm	25% Arbeitsweg Working stroke		30% Arbeitsweg Working stroke		40% Arbeitsweg Working stroke		max. Federweg max. deflection mm				
						mm	N	mm	N	mm	N					
25	076	5,4	2,7	12,5	28,0	19,0	532	22,8	638	30,4	851	37,5				
	089				24,0	22,3	535	26,7	641	35,6	854	43,5				
	102				21,1	25,5	538	30,6	646	40,8	861	51,1				
	115				18,7	28,8	539	34,5	645	46,0	860	58,1				
	127				16,7	31,8	531	38,1	636	50,8	848	64,1				
	139				15,4	34,8	536	41,7	643	55,6	857	70,4				
	152				14,0	38,0	532	45,6	638	60,8	851	77,1				
	178				12,5	44,5	556	53,4	668	71,2	890	93,1				
	203				10,4	50,8	528	60,9	633	81,2	844	103,0				
	305				7,0	76,3	534	91,5	641	122,0	854	156,0				
	32				038	6,8	3,3	16,0	94,0	9,5	893	11,4	1072	15,2	1429	18,3
044		79,5	11,0	875	13,2				1049	17,6	1399	21,5				
051		67,0	12,8	858	15,3				1025	20,4	1367	25,5				
064		53,0	16,0	848	19,2				1018	25,6	1357	31,9				
076		44,0	19,0	836	22,8				1003	30,4	1338	38,6				
089		37,2	22,3	830	26,7				993	35,6	1324	46,5				
102		32,0	25,5	816	30,6				979	40,8	1306	53,2				
115		29,0	28,8	835	34,5				1001	46,0	1334	60,0				
127		25,0	31,8	795	38,1				953	50,8	1270	66,7				
139		23,2	34,8	805	41,7				966	55,6	1288	71,8				
152		21,5	38,0	817	45,6				980	60,8	1307	78,5				
178		18,2	44,5	810	53,4				972	71,2	1296	94,4				
203		15,8	50,8	803	60,9				962	81,2	1283	107,0				
254		12,5	63,5	794	76,2				953	101,6	1270	136,0				
305		10,3	76,3	786	91,5				942	122,0	1257	163,0				
40		051	8,1	4,0	20,0				92,0	12,8	1178	15,3	1408	20,4	1877	25,5
		064							73,0	16,0	1168	19,2	1402	25,6	1869	31,4
		076							63,0	19,0	1197	22,8	1436	30,4	1915	37,8
	089	51,0				22,3	1137	26,7	1362	35,6	1816	44,3				
	102	43,0				25,5	1097	30,6	1316	40,8	1754	50,7				
	115	39,6				28,8	1140	34,5	1366	46,0	1822	58,1				
	127	37,0				31,8	1177	38,1	1410	50,8	1880	64,6				
	139	32,2				34,8	1120	41,7	1344	55,6	1792	70,1				
	152	28,0				38,0	1064	45,6	1277	60,8	1702	76,6				
	178	25,2				44,5	1121	53,4	1346	71,2	1794	90,4				
	203	22,7				50,8	1153	60,9	1382	81,2	1843	102,0				
	254	17,0				63,5	1080	76,2	1295	101,6	1727	129,0				
	305	14,8				76,3	1129	91,5	1354	122,0	1806	156,0				
	50	064				10,9	5,3	25,0	156,0	16,0	2496	19,2	2995	25,6	3994	31,0
		076							125,0	19,0	2375	22,8	2850	30,4	3800	37,2
		089							109,0	22,3	2431	26,7	2910	35,6	3880	43,6
102		94,0	25,5	2397	30,6				2876	40,8	3835	50,3				
115		81,0	28,8	2333	34,5				2795	46,0	3726	58,1				
127		71,0	31,8	2358	38,1				2705	50,8	3607	63,7				
139		67,0	34,8	2328	41,7				2793	55,6	3724	69,5				
152		60,0	38,0	2280	45,6				2736	60,8	3648	76,5				
178		52,0	44,5	2314	53,4				2777	71,2	3702	91,9				
203		44,0	50,8	2235	60,9				2680	81,2	3573	105,0				
254		35,0	63,5	2223	76,2				2667	101,6	3556	131,0				
305		28,5	76,3	2175	91,5				2608	122,0	3477	155,0				
63		076	11,0	7,8	38,0				189,0	19,0	3591	22,8	4309	30,4	5746	36,5
		089							158,0	22,3	3523	26,7	4219	35,6	5625	43,4
	102	131,0				25,5	3341	30,6	4009	40,8	5345	49,7				
	115	116,0				28,8	3341	34,5	4002	46,0	5336	55,6				
	127	103,0				31,8	3275	38,1	3924	50,8	5232	62,7				
	152	84,3				38,0	3203	45,6	3844	60,8	5125	77,1				
	178	71,5				44,5	3182	53,4	3818	71,2	5091	92,2				
	203	61,7				50,8	3134	60,9	3758	81,2	5010	103,0				
	254	47,0				63,5	2985	76,2	3581	101,6	4775	130,0				
	305	38,2				76,3	2915	91,5	3495	122,0	4660	157,0				

[FE]



FE 832 MB

FE 832 MB / 10 x 025

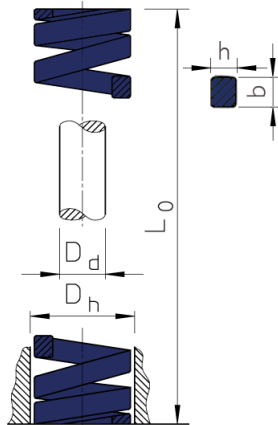

Dh mm	Lo mm	b mm	h mm	Dd mm	C N/mm	25% Arbeitsweg Working stroke		30% Arbeitsweg Working stroke		37,5% Arbeitsweg Working stroke		max. Federweg max. deflection mm				
						mm	N	mm	N	mm	N					
10	025	1,9	1,3	5,0	16,0	6,3	101	7,5	120	9,4	150	10,2				
	032				13,0	8,0	104	9,6	125	12,0	156	14,2				
	038				11,9	9,5	113	11,4	136	14,3	170	16,8				
	044				10,3	11,0	113	13,2	136	16,5	170	19,4				
	051				8,9	12,8	114	15,3	136	19,1	170	23,4				
	064				7,5	16,0	120	19,2	144	24,0	180	28,2				
	076				5,3	19,0	101	22,8	121	28,5	151	34,2				
	305				1,6	76,3	122	91,5	146	114,4	183	134,0				
13	025	2,5	1,5	6,3	30,0	6,3	189	7,5	225	9,4	282	11,9				
	032				24,8	8,0	198	9,6	238	12,0	298	16,2				
	038				21,4	9,5	203	11,4	244	14,3	306	18,7				
	044				18,5	11,0	204	13,2	244	16,5	305	21,3				
	051				15,5	12,8	198	15,3	237	19,1	296	25,6				
	064				12,1	16,0	194	19,2	232	24,0	290	32,4				
	076				10,2	19,0	194	22,8	233	28,5	291	39,0				
	089				8,4	22,3	187	26,7	224	33,4	281	45,9				
	102				6,3	25,5	161	30,6	193	38,3	241	52,3				
	305				2,1	76,3	160	91,5	192	114,4	240	153,0				
	16				025	3,2	2,0	8,0	49,4	6,3	311	7,5	371	9,4	464	10,5
032		37,1	8,0	297	9,6				356	12,0	445	13,2				
038		33,9	9,5	322	11,4				386	14,3	485	17,2				
044		30,0	11,0	330	13,2				396	16,5	495	19,4				
051		26,4	12,8	338	15,3				404	19,1	504	24,2				
064		20,5	16,0	328	19,2				394	24,0	492	29,2				
076		17,8	19,0	338	22,8				406	28,5	507	36,3				
089		15,2	22,3	339	26,7				406	33,4	508	41,7				
102		13,5	25,5	344	30,6				413	38,3	517	48,9				
115		11,8	28,8	340	34,5				407	43,1	509	53,1				
305		4,8	76,3	366	91,5				439	114,4	549	142,0				
20		025	4,1	2,4	10,0				98,0	6,3	617	7,5	735	9,4	921	10,5
		032							72,6	8,0	581	9,6	697	12,0	871	13,9
	038	56,0				9,5	532	11,4	638	14,3	801	16,6				
	044	47,5				11,0	523	13,2	627	16,5	784	18,8				
	051	41,7				12,8	534	15,3	638	19,1	796	23,1				
	064	32,3				16,0	517	19,2	620	24,0	775	27,5				
	076	25,1				19,0	477	22,8	572	28,5	715	33,8				
	089	22,0				22,3	491	26,7	587	33,4	735	39,7				
	102	19,8				25,5	505	30,6	606	38,3	758	47,3				
	115	18,1				28,8	521	34,5	624	43,1	780	52,5				
	127	16,6				31,8	528	38,1	632	47,6	790	56,9				
	139	15,2				34,8	529	41,7	634	52,1	793	62,1				
	152	13,2				38,0	500	45,6	600	57,0	750	67,6				
	305	6,1				76,3	465	91,5	558	114,4	698	143,0				
	25	025				5,4	3,3	12,5	147,0	6,3	926	7,5	1103	9,4	1382	10,2
032		118,0	8,0	944	9,6				1133	12,0	1416	13,7				
038		93,0	9,5	884	11,4				1060	14,3	1330	15,7				
044		80,8	11,0	889	13,2				1067	16,5	1333	18,2				
051		68,6	12,8	878	15,3				1050	19,1	1310	21,7				
064		53,0	16,0	848	19,2				1018	24,0	1272	26,0				



Dh mm	L0 mm	b mm	h mm	Dd mm	C N/mm	25% Arbeitsweg Working stroke		30% Arbeitsweg Working stroke		37,5% Arbeitsweg Working stroke		max. Federweg max. deflection mm				
						mm	N	mm	N	mm	N					
25	076	5,4	3,3	12,5	43,2	19,0	821	22,8	985	28,5	1231	32,3				
	089				38,2	22,3	852	26,7	1020	33,4	1276	38,0				
	102				33,0	25,5	842	30,6	1010	38,3	1264	43,0				
	115				28,0	28,8	806	34,5	966	43,1	1207	48,6				
	127				25,9	31,8	824	38,1	987	47,6	1233	53,7				
	139				23,4	34,8	812	41,7	974	52,1	1218	59,4				
	152				20,8	38,0	790	45,6	948	57,0	1186	63,8				
	178				17,8	44,5	792	53,4	951	66,8	1189	76,6				
	203				15,8	50,8	803	60,9	962	76,1	1202	88,4				
	305				10,2	76,3	778	91,5	933	114,4	1167	135,0				
	32				038	6,8	4,0	16,0	185,0	9,5	1758	11,4	2109	14,3	2646	16,3
044		158,0	11,0	1738	13,2				2086	16,5	2607	18,9				
051		134,0	12,8	1715	15,3				2050	19,1	2559	23,1				
064		99,0	16,0	1584	19,2				1901	24,0	2376	28,5				
076		80,5	19,0	1530	22,8				1835	28,5	2294	34,2				
089		69,1	22,3	1541	26,7				1845	33,4	2308	40,4				
102		58,8	25,5	1499	30,6				1799	38,3	2252	48,0				
115		51,5	28,8	1483	34,5				1777	43,1	2220	54,3				
127		44,8	31,8	1425	38,1				1707	47,6	2132	59,2				
139		42,6	34,8	1481	41,7				1777	52,1	2221	65,3				
152		37,8	38,0	1436	45,6				1724	57,0	2155	73,0				
178		32,5	44,5	1446	53,4				1736	66,8	2171	84,5				
203		28,9	50,8	1468	60,9				1760	76,1	2199	96,9				
254		21,4	63,5	1359	76,2				1631	95,3	2039	121,0				
305		18,3	76,3	1396	91,5				1674	114,4	2094	147,0				
40		051	8,2	4,7	20,0				181,6	12,8	2324	15,3	2778	19,1	3469	21,4
		064							140,0	16,0	2240	19,2	2688	24,0	3360	26,8
	076	108,0				19,0	2052	22,8	2462	28,5	3078	32,7				
	089	90,7				22,3	2023	26,7	2422	33,4	3029	39,0				
	102	81,0				25,5	2066	30,6	2479	38,3	3102	44,1				
	115	71,8				28,8	2068	34,5	2477	43,1	3095	50,6				
	127	62,7				31,8	1994	38,1	2389	47,6	2985	55,9				
	139	57,9				34,8	2013	41,7	2415	52,1	3019	61,8				
	152	51,6				38,0	1961	45,6	2353	57,0	2941	67,5				
	178	44,1				44,5	1962	53,4	2355	66,8	2946	77,2				
	203	36,7				50,8	1864	60,9	2235	76,1	2793	91,8				
	254	30,1				63,5	1911	76,2	2294	95,3	2869	113,0				
	305	24,6				76,3	1877	91,5	2251	114,4	2814	138,0				
	50	064				11,1	5,8	25,0	209,0	16,0	3344	19,2	4013	24,0	5016	28,2
		076							168,0	19,0	3192	22,8	3830	28,5	4788	34,9
089		140,0	22,3	3122	26,7				3738	33,4	4676	39,2				
102		119,0	25,5	3035	30,6				3641	38,3	4558	47,3				
115		106,0	28,8	3053	34,5				3657	43,1	4569	52,6				
127		97,0	31,8	3085	38,1				3696	47,6	4617	59,8				
139		87,6	34,8	3045	41,7				3654	52,1	4568	65,1				
152		80,0	38,0	3040	45,6				3648	57,0	4560	70,8				
178		69,5	44,5	3093	53,4				3711	66,8	4643	84,2				
203		59,8	50,8	3038	60,9				3642	76,1	4551	96,5				
229		50,9	57,3	2917	68,7				3497	85,9	4372	108,0				
254		43,9	63,5	2788	76,2				3345	95,3	4184	122,0				
305		38,6	76,3	2945	91,5				3532	114,4	4416	147,0				
63		076	11,5	9,1	38,0				312,0	19,0	5928	22,8	7114	28,5	8892	30,7
		089							260,0	22,3	5789	26,7	6942	33,4	8684	36,5
	102	221,0				25,5	5636	30,6	6763	38,3	8464	43,6				
	115	187,0				28,8	5386	34,5	6452	43,1	8060	48,9				
	127	168,0				31,8	5342	38,1	6401	47,6	7997	54,2				
	152	136,0				38,0	5168	45,6	6202	57,0	7752	65,7				
	178	114,0				44,5	5073	53,4	6088	66,8	7615	76,5				
	203	100,0				50,8	5080	60,9	6090	76,1	7610	88,0				
	229	89,2				57,3	5111	68,7	6128	85,9	7662	104,0				
	254	78,4				63,5	4978	76,2	5974	95,3	7472	112,0				
	305	64,7				76,3	4937	91,5	5920	114,4	7402	134,0				

[FE]



FE 833 SB

FE 833 SB / 10 x 025

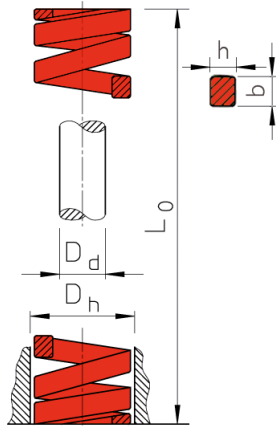

Dh mm	Lo mm	b mm	h mm	Dd mm	C N/mm	20% Arbeitsweg Working stroke		25% Arbeitsweg Working stroke		30% Arbeitsweg Working stroke		max. Federweg max. deflection mm
						mm	N	mm	N	mm	N	
10	025	1,9	1,5	5,0	22,1	5,0	111	6,3	139	7,5	166	9,2
	032				17,5	6,4	112	8,0	140	9,6	168	12,1
	038				17,1	7,6	130	9,5	162	11,4	195	13,2
	044				15,0	8,8	132	11,0	165	13,2	198	15,1
	051				12,8	10,2	131	12,8	164	15,3	196	19,5
	064				10,7	12,8	137	16,0	171	19,2	205	21,8
	076				7,5	15,2	114	19,0	143	22,8	171	27,9
	305				2,1	61,0	128	76,3	160	91,5	192	127,0
13	025	2,4	1,9	6,3	42,1	5,0	211	6,3	265	7,5	316	9,8
	032				33,2	6,4	212	8,0	266	9,6	319	13,6
	038				29,3	7,6	223	9,5	278	11,4	334	14,6
	044				24,6	8,8	216	11,0	271	13,2	325	18,1
	051				19,6	10,2	200	12,8	251	15,3	300	22,3
	064				15,0	12,8	192	16,0	240	19,2	288	27,3
	076				13,2	15,2	201	19,0	251	22,8	301	33,1
	089				11,4	17,8	203	22,3	254	26,7	304	38,9
	102				8,4	20,4	171	25,5	214	30,6	257	43,8
	305				2,8	61,0	171	76,3	214	91,5	256	140,0
	16				025	3,1	2,5	8,0	75,7	5,0	379	6,3
032		52,8	6,4	338	8,0				422	9,6	507	10,5
038		48,5	7,6	369	9,5				461	11,4	553	13,6
044		42,8	8,8	377	11,0				471	13,2	565	15,9
051		37,1	10,2	378	12,8				475	15,3	568	18,9
064		30,3	12,8	388	16,0				485	19,2	582	24,9
076		25,7	15,2	391	19,0				488	22,8	586	29,2
089		21,7	17,8	386	22,3				484	26,7	579	34,5
102		19,3	20,4	394	25,5				492	30,6	591	39,1
115		15,7	23,0	361	28,8				452	34,5	542	44,0
305		7,1	61,0	433	76,3				542	91,5	650	104,0
20		025	4,0	3,3	10,0				216,0	5,0	1080	6,3
	032	168,0				6,4	1075	8,0	1344	9,6	1613	10,9
	038	129,0				7,6	980	9,5	1226	11,4	1471	12,5
	044	112,0				8,8	986	11,0	1232	13,2	1478	15,0
	051	94,0				10,2	959	12,8	1203	15,3	1438	17,6
	064	72,1				12,8	923	16,0	1154	19,2	1384	22,6
	076	59,7				15,2	907	19,0	1134	22,8	1361	27,5
	089	50,5				17,8	899	22,3	1126	26,7	1348	31,7
	102	44,2				20,4	902	25,5	1127	30,6	1353	37,5
	115	38,4				23,0	883	28,8	1106	34,5	1325	42,6
	127	34,1				25,4	866	31,8	1084	38,1	1299	45,5
	139	31,2				27,8	868	34,8	1085	41,7	1302	50,1
	152	28,2				30,4	857	38,0	1072	45,6	1286	55,8
	305	15,0				61,0	915	76,3	1145	91,5	1373	114,0
25	025	5,5	4,2	12,5	375,1	5,0	1875	6,3	2363	7,5	2813	8,5
	032				297,0	6,4	1901	8,0	2376	9,6	2851	11,0
	038				219,0	7,6	1664	9,5	2081	11,4	2497	12,6
	044				187,0	8,8	1646	11,0	2057	13,2	2468	14,8
	051				156,0	10,2	1591	12,8	1997	15,3	2387	17,9
	064				123,0	12,8	1574	16,0	1968	19,2	2362	23,1



Dh mm	Lo mm	b mm	h mm	Dd mm	C N/mm	20% Arbeitsweg Working stroke		25% Arbeitsweg Working stroke		30% Arbeitsweg Working stroke		max. Federweg max. deflection mm				
						mm	N	mm	N	mm	N					
25	076	5,5	4,2	12,5	99,0	15,2	1505	19,0	1881	22,8	2257	26,3				
	089				84,0	17,8	1495	22,3	1873	26,7	2243	30,5				
	102				73,0	20,4	1489	25,5	1862	30,6	2234	37,3				
	115				65,0	23,0	1495	28,8	1872	34,5	2243	41,9				
	127				57,7	25,4	1466	31,8	1835	38,1	2198	46,2				
	139				53,1	27,8	1476	34,8	1844	41,7	2213	49,3				
	152				47,8	30,4	1453	38,0	1816	45,6	2180	55,7				
	178				41,0	35,6	1460	44,5	1825	53,4	2189	65,1				
	203				35,8	40,6	1453	50,8	1819	60,9	2180	74,5				
	305				22,9	61,0	1397	76,3	1747	91,5	2095	110,0				
32	038	7,1	5,4	16,0	388,0	7,6	2949	9,5	3686	11,4	4423	12,5				
	044				324,0	8,8	2851	11,0	3564	13,2	4277	14,9				
	051				272,0	10,2	2774	12,8	3482	15,3	4162	17,8				
	064				212,0	12,8	2714	16,0	3392	19,2	4070	22,4				
	076				172,0	15,2	2614	19,0	3268	22,8	3922	26,1				
	089				141,0	17,8	2510	22,3	3144	26,7	3765	30,8				
	102				122,0	20,4	2489	25,5	3111	30,6	3733	36,8				
	115				107,0	23,0	2461	28,8	3082	34,5	3692	41,4				
	127				93,0	25,4	2362	31,8	2957	38,1	3543	44,4				
	139				86,6	27,8	2408	34,8	3010	41,7	3612	48,5				
	152				78,0	30,4	2371	38,0	2964	45,6	3557	54,8				
	178				67,2	35,6	2392	44,5	2990	53,4	3588	63,6				
	203				59,1	40,6	2399	50,8	3002	60,9	3599	72,5				
	254				46,4	50,8	2357	63,5	2946	76,2	3536	92,8				
	305				38,0	61,0	2318	76,3	2899	91,5	3477	112,0				
	40				051	8,4	6,2	20,0	350,0	10,2	3570	12,8	4480	15,3	5355	17,0
064		269,0	12,8	3443	16,0				4304	19,2	5165	21,9				
076		219,0	15,2	3329	19,0				4161	22,8	4993	26,7				
089		190,0	17,8	3382	22,3				4237	26,7	5073	31,3				
102		163,0	20,4	3325	25,5				4157	30,6	4988	37,1				
115		142,0	23,0	3266	28,8				4090	34,5	4899	41,0				
127		128,0	25,4	3251	31,8				4070	38,1	4877	46,5				
139		115,8	27,8	3220	34,8				4025	41,7	4830	53,1				
152		105,0	30,4	3192	38,0				3990	45,6	4788	56,1				
178		89,0	35,6	3168	44,5				3961	53,4	4753	67,4				
203		77,0	40,6	3126	50,8				3912	60,9	4689	76,2				
254		61,0	50,8	3099	63,5				3874	76,2	4648	96,2				
305		51,0	61,0	3111	76,3				3891	91,5	4667	115,0				
50		064	11,1	7,6	25,0				413,0	12,8	5286	16,0	6608	19,2	7930	22,4
	076	339,0				15,2	5153	19,0	6441	22,8	7729	26,5				
	089	288,0				17,8	5126	22,3	6408	26,7	7690	31,5				
	102	245,0				20,4	4998	25,5	6248	30,6	7497	37,6				
	115	215,0				23,0	4945	28,8	6182	34,5	7418	42,7				
	127	192,0				25,4	4877	31,8	6096	38,1	7315	47,5				
	139	169,2				27,8	4704	34,8	5880	41,7	7056	51,8				
	152	154,0				30,4	4682	38,0	5852	45,6	7022	57,8				
	178	134,0				35,6	4770	44,5	5963	53,4	7156	68,5				
	203	117,0				40,6	4750	50,8	5938	60,9	7125	77,6				
	254	89,0				50,8	4521	63,5	5652	76,2	6782	97,9				
	305	73,0				61,0	4453	76,3	5567	91,5	6680	121,0				
	63	076				11,6	12,3	38,0	618,0	15,2	9394	19,0	11742	22,8	14090	24,7
		089							515,0	17,8	9167	22,3	11485	26,7	13751	30,0
102		438,0	20,4	8935	25,5				11169	30,6	13403	35,1				
115		370,0	23,0	8510	28,8				10656	34,5	12765	37,5				
127		333,0	25,4	8458	31,8				10589	38,1	12687	45,9				
152		269,0	30,4	8178	38,0				10222	45,6	12266	56,5				
178		226,0	35,6	8046	44,5				10057	53,4	12068	66,8				
203		198,0	40,6	8039	50,8				10058	60,9	12058	78,8				
254		155,0	50,8	7874	63,5				9843	76,2	11811	102,0				
305		128,0	61,0	7808	76,3				9766	91,5	11712	122,0				

[FE]



FE 834 BB

 FE 834 BB / 10 x 025

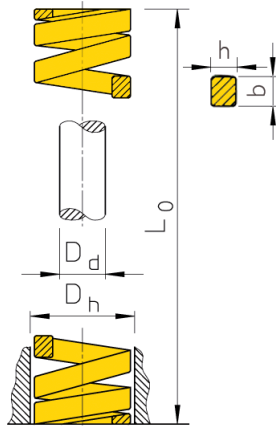

Dh mm	L0 mm	b mm	h mm	Dd mm	C N/mm	17% Arbeitsweg Working stroke		20% Arbeitsweg Working stroke		25% Arbeitsweg Working stroke		max. Federweg max. deflection mm 				
						mm	N	mm	N	mm	N					
10	025	1,9	1,6	5,0	36,8	4,3	158	5,0	184	6,3	232	7,7				
	032				27,9	5,4	151	6,4	179	8,0	223	10,6				
	038				23,7	6,5	154	7,6	180	9,5	225	12,6				
	044				19,2	7,5	144	8,8	169	11,0	211	13,8				
	051				16,5	8,7	144	10,2	168	12,8	211	16,2				
	064				13,2	10,9	144	12,8	169	16,0	211	20,4				
	076				10,9	12,9	141	15,2	166	19,0	207	25,2				
	305				2,6	51,9	135	61,0	159	76,3	198	111,0				
13	025	2,6	2,0	6,3	58,5	4,3	252	5,0	293	6,3	369	8,1				
	032				43,9	5,4	237	6,4	281	8,0	351	9,9				
	038				36,0	6,5	234	7,6	274	9,5	342	12,9				
	044				30,3	7,5	227	8,8	267	11,0	333	14,1				
	051				26,2	8,7	228	10,2	267	12,8	335	17,4				
	064				21,2	10,9	231	12,8	271	16,0	339	21,0				
	076				17,1	12,9	221	15,2	260	19,0	325	26,4				
	089				14,5	15,1	219	17,8	258	22,3	323	31,5				
	102				12,7	17,3	220	20,4	259	25,5	324	36,0				
	305				4,3	51,9	223	61,0	262	76,3	328	111,0				
	16				025	3,2	2,9	8,0	118,0	4,3	507	5,0	590	6,3	743	8,5
032		89,0	5,4	481	6,4				570	8,0	712	11,0				
038		72,1	6,5	469	7,6				548	9,5	685	13,2				
044		60,9	7,5	457	8,8				536	11,0	670	14,7				
051		52,3	8,7	455	10,2				533	12,8	669	17,7				
064		41,2	10,9	449	12,8				527	16,0	659	21,9				
076		34,1	12,9	440	15,2				518	19,0	648	27,8				
089		29,5	15,1	445	17,8				525	22,3	658	31,2				
102		25,6	17,3	443	20,4				522	25,5	653	37,9				
115		22,4	19,6	439	23,0				515	28,8	645	44,5				
305		8,4	51,9	436	61,0				512	76,3	641	113,0				
20		025	4,1	3,8	10,0				293,0	4,3	1260	5,0	1465	6,3	1846	6,9
		032							224,0	5,4	1210	6,4	1434	8,0	1792	9,4
	038	177,0				6,5	1151	7,6	1345	9,5	1682	12,0				
	044	149,0				7,5	1118	8,8	1311	11,0	1639	13,5				
	051	128,0				8,4	1114	10,2	1306	12,8	1638	16,2				
	064	99,0				10,9	1079	12,8	1267	16,0	1584	21,2				
	076	81,7				12,9	1054	15,2	1242	19,0	1552	24,7				
	089	69,5				15,1	1049	17,8	1237	22,3	1550	28,8				
	102	60,6				17,3	1048	20,4	1236	25,5	1545	34,8				
	115	53,0				19,6	1039	23,0	1219	28,8	1526	39,0				
	127	47,5				21,6	1026	25,4	1207	31,8	1511	43,0				
	139	43,3				23,6	1023	27,8	1204	34,8	1505	45,3				
	152	39,0				25,8	1006	30,4	1186	38,0	1482	50,4				
	305	21,2				51,9	1100	61,0	1293	76,3	1618	103,0				
25	025	5,4	4,6	12,5	459,0	4,3	1974	5,0	2295	6,3	2892	7,3				
	032				374,4	5,4	2022	6,4	2396	8,0	2995	10,7				
	038				346,0	6,5	2249	7,6	2630	9,5	3287	12,0				
	044				244,0	7,5	1830	8,8	2147	11,0	2684	14,4				
	051				207,5	8,7	1805	10,2	2117	12,8	2656	17,4				
	064				161,0	10,9	1755	12,8	2061	16,0	2576	21,4				



Dh	Lo	b	h	Dd	C	17% Arbeitsweg		20% Arbeitsweg		25% Arbeitsweg		max. Federweg max. deflection				
						Working stroke	N	Working stroke	N	Working stroke	N					
mm	mm	mm	mm	mm	N/mm	mm	N	mm	N	mm	N	mm				
25	076	5,4	4,6	12,5	130,8	12,9	1687	15,2	1988	19,0	2485	26,9				
	089				110,7	15,1	1663	17,8	1967	22,3	2464	30,9				
	102				96,3	17,3	1666	20,4	1965	25,5	2456	36,7				
	115				85,7	19,6	1680	23,0	1971	28,8	2468	40,3				
	127				76,3	21,6	1648	25,4	1938	31,8	2426	45,1				
	139				69,4	23,6	1640	27,8	1929	34,8	2412	47,6				
	152				63,5	25,8	1638	30,4	1930	38,0	2413	53,5				
	178				53,9	30,3	1633	35,6	1919	44,5	2399	63,9				
	203				47,0	34,5	1622	40,6	1908	50,8	2388	70,2				
	305				30,9	51,9	1604	61,0	1885	76,3	2358	110,0				
32	038	7,3	5,9	16,0	528,2	6,5	3433	7,6	4014	9,5	5018	11,4				
	044				424,4	7,5	3183	8,8	3735	11,0	4668	13,7				
	051				353,0	8,7	3071	10,2	3601	12,8	4518	15,6				
	064				269,2	10,9	2934	12,8	3446	16,0	4307	20,0				
	076				218,5	12,9	2819	15,2	3321	19,0	4152	24,4				
	089				180,3	15,1	2723	17,8	3209	22,3	4021	29,7				
	102				155,0	17,3	2682	20,4	3162	25,5	3953	35,1				
	115				140,0	19,6	2744	23,0	3220	28,8	4032	39,0				
	127				124,0	21,6	2678	25,4	3150	31,8	3943	42,8				
	139				113,1	23,6	2673	27,8	3144	34,8	3931	48,6				
	152				102,0	25,8	2632	30,4	3101	38,0	3876	52,4				
	178				88,2	30,3	2672	35,6	3140	44,5	3925	60,9				
	203				76,0	34,5	2622	40,6	3086	50,8	3861	69,2				
	254				60,8	43,2	2627	50,8	3089	63,5	3861	88,1				
	305				49,0	51,9	2543	61,0	2989	76,3	3739	104,0				
	40				051	8,4	7,5	20,0	628,0	8,7	5464	10,2	6406	12,8	8038	15,0
064		487,0	10,9	5308	12,8				6234	16,0	7792	19,5				
076		379,0	12,9	4889	15,2				5761	19,0	7201	23,3				
089		321,0	15,1	4847	17,8				5714	22,3	7158	26,7				
102		281,0	17,3	4861	20,4				5732	25,5	7166	33,8				
115		245,0	19,6	4802	23,0				5635	28,8	7056	36,2				
127		221,0	21,6	4774	25,4				5613	31,8	7028	40,7				
139		191,4	23,6	4522	27,8				5320	34,8	6650	44,5				
152		168,0	25,8	4334	30,4				5107	38,0	6384	49,6				
178		146,0	30,3	4424	35,6				5198	44,5	6497	59,9				
203		132,0	34,5	4554	40,6				5359	50,8	6706	67,1				
254		107,0	43,2	4622	50,8				5436	63,5	6795	86,3				
305		87,8	51,9	4557	61,0				5356	76,3	6699	104,0				
50		064	11,5	9,0	25,0				709,0	10,9	7728	12,8	9075	16,0	11344	19,3
	076	572,0				12,9	7379	15,2	8694	19,0	10868	24,2				
	089	475,0				15,1	7173	17,8	8455	22,3	10593	28,0				
	102	405,0				17,3	7007	20,4	8262	25,5	10328	33,5				
	115	352,0				19,6	6899	23,0	8096	28,8	10138	38,6				
	127	316,0				21,6	6826	25,4	8026	31,8	10049	41,4				
	139	276,0				23,6	6521	27,8	7672	34,8	9590	47,3				
	152	239,0				25,8	6166	30,4	7266	38,0	9082	50,2				
	178	215,0				30,3	6515	35,6	7654	44,5	9568	61,1				
	203	187,0				34,5	6452	40,6	7592	50,8	9500	67,7				
	254	153,0				43,5	6610	50,8	7772	63,5	9716	87,0				
	305	127,0				51,9	6591	61,0	7747	76,3	9690	104,0				
	63	076*				11,6	14,9	38,0	952,0	12,9	12280	15,2	14470	-	-	15,5
		089*							819,0	15,1	12360	17,8	14580	-	-	20,0
102		700,0	17,3	12110	20,4				14280	25,5	17850	30,7				
115		620,0	19,6	12152	23,0				14260	28,8	17860	34,9				
127		565,0	21,6	12204	25,4				14351	31,8	17967	38,0				
152		458,0	25,8	11816	30,4				13923	38,0	17404	47,2				
178		384,0	30,3	11635	35,6				13670	44,5	17088	55,8				
203		337,0	34,5	11627	40,6				13682	50,8	17120	64,8				
254		263,0	43,2	11362	50,8				13360	63,5	16701	86,7				
305		218,0	51,9	11314	61,0				13298	76,3	16633	106,0				

* = max. Federweg 20% / * = max. spring deflection 20%

FE 835 LB

 **FE 835 LB / 10 x 025**

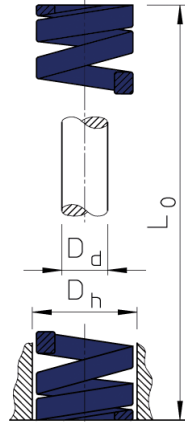

Dh mm	Lo mm	Dd mm	C N/mm	25% Arbeitsweg Working stroke		40% Arbeitsweg Working stroke		50% Arbeitsweg Working stroke	
				mm	N	mm	N	mm	N
10	025	5,0	14,4	6,3	90	10,0	144	12,5	180
	032		12,3	8,0	99	12,8	158	16,0	197
	038		9,8	9,5	93	15,2	149	19,0	186
	044		8,8	11,0	97	17,6	155	22,0	194
	051		7,5	12,8	96	20,4	153	25,5	191
	064		4,9	16,0	79	25,6	126	32,0	157
	076		3,8	19,0	72	30,4	115	38,0	144
	305		1,2	76,3	92	122,0	146	152,5	183
13	025	6,3	18,9	6,3	118	10,0	189	12,5	236
	032		15,4	8,0	123	12,8	197	16,0	246
	038		13,5	9,5	129	15,2	206	19,0	257
	044		11,8	11,0	130	17,6	208	22,0	260
	051		10,0	12,8	128	20,4	204	25,5	255
	064		7,6	16,0	122	25,6	194	32,0	243
	076		5,9	19,0	112	30,4	179	38,0	224
	089		4,8	22,3	107	35,6	171	44,5	214
	102		3,4	25,5	87	40,8	138	51,0	173
	305		1,6	76,3	122	122,0	195	152,5	244
16	025	8,0	22,9	6,3	143	10,0	229	12,5	286
	032		22,5	8,0	180	12,8	288	16,0	360
	038		18,9	9,5	180	15,2	287	19,0	359
	044		16,8	11,0	185	17,6	296	22,0	370
	051		15,4	12,8	197	20,4	314	25,5	393
	064		10,5	16,0	168	25,6	269	32,0	336
	076		9,8	19,0	186	30,4	298	38,0	372
	089		8,4	22,3	187	35,6	299	44,5	374
	102		7,7	25,5	197	40,8	314	51,0	393
	115		5,9	28,8	170	46,0	271	57,5	339
	305		2,5	76,3	191	122,0	305	152,5	381
	20		025	10,0	53,0	6,3	332	10,0	530
032		43,1	8,0		345	12,8	552	16,0	690
038		34,3	9,5		326	15,2	522	19,0	652
044		30,4	11,0		335	17,6	535	22,0	669
051		25,5	12,8		325	20,4	520	25,5	650
064		20,6	16,0		330	25,6	527	32,0	659
076		16,2	19,0		308	30,4	493	38,0	616
089		14,2	22,3		316	35,6	506	44,5	632
102		12,2	25,5		311	40,8	498	51,0	622
115		11,0	28,8		317	46,0	506	57,5	633
127		9,8	31,8		311	50,8	498	63,5	622
140		8,3	35,0		291	56,0	465	70,0	581
152		7,2	38,0		274	60,8	438	76,0	547
305		4,1	76,3		313	122,0	500	152,5	625
25	025	12,5	107,9	6,3	675	10,0	1079	12,5	1349
	032		80,4	8,0	643	12,8	1029	16,0	1286
	038		62,8	9,5	597	15,2	954	19,0	1193
	044		52,0	11,0	572	17,6	915	22,0	1144
	051		43,1	12,8	550	20,4	879	25,5	1099
	064		35,3	16,0	565	25,6	904	32,0	1130



Dh mm	Lo mm	Dd mm	C N/mm	25% Arbeitsweg Working stroke		40% Arbeitsweg Working stroke		50% Arbeitsweg Working stroke	
				mm	N	mm	N	mm	N
25	076	12,5	29,4	19,0	559	30,4	894	38,0	1117
	089		24,5	22,3	545	35,6	872	44,5	1090
	102		21,6	25,5	551	40,8	882	51,0	1102
	115		18,6	28,8	535	46,0	856	57,5	1070
	127		17,2	31,8	546	50,8	874	63,5	1092
	140		15,7	35,0	550	56,0	879	70,0	1099
	152		14,7	38,0	559	60,8	894	76,0	1117
	178		12,7	44,5	565	71,2	904	89,0	1130
	203		10,8	50,8	548	81,2	877	101,5	1096
	305		7,4	76,3	565	122,0	903	152,5	1129
32	038	16,0	88,3	9,5	839	15,2	1342	19,0	1678
	044		76,5	11,0	842	17,6	1346	22,0	1683
	051		60,8	12,8	775	20,4	1240	25,5	1550
	064		49,0	16,0	784	25,6	1254	32,0	1568
	076		41,2	19,0	783	30,4	1253	38,0	1566
	089		35,3	22,3	786	35,6	1257	44,5	1571
	102		30,4	25,5	775	40,8	1240	51,0	1550
	115		27,5	28,8	791	46,0	1265	57,5	1581
	127		23,5	31,8	746	50,8	1194	63,5	1492
	140		21,6	35,0	756	56,0	1210	70,0	1512
	152		19,6	38,0	745	60,8	1192	76,0	1490
	178		17,7	44,5	788	71,2	1260	89,0	1575
	203		14,7	50,8	746	81,2	1194	101,5	1492
	254		12,7	63,5	807	101,6	1290	127,0	1613
	305		9,8	76,3	748	122,0	1196	152,5	1495
	40		051	20,0	81,4	12,8	1038	20,4	1661
064		62,8	16,0		1005	25,6	1608	32,0	2010
076		51,0	19,0		969	30,4	1550	38,0	1938
089		43,1	22,3		959	35,6	1534	44,5	1918
102		36,3	25,5		926	40,8	1481	51,0	1851
115		32,4	28,8		932	46,0	1490	57,5	1863
127		29,4	31,8		934	50,8	1494	63,5	1867
140		27,0	35,0		945	56,0	1512	70,0	1890
152		24,5	38,0		931	60,8	1490	76,0	1862
178		21,6	44,5		961	71,2	1538	89,0	1922
203		18,6	50,8		944	81,2	1510	101,5	1888
254		14,7	63,5		934	101,6	1494	127,0	1867
305		10,8	76,3		824	122,0	1318	152,5	1647
50		064	25,0		156,9	16,0	2511	25,6	4017
	076	132,4		19,0	2516	30,4	4025	38,0	5031
	089	114,7		22,3	2552	35,6	4083	44,5	5104
	102	98,1		25,5	2502	40,8	4002	51,0	5003
	115	87,3		28,8	2510	46,0	4016	57,5	5020
	127	77,5		31,8	2461	50,8	3937	63,5	4921
	140	69,6		35,0	2436	56,0	3898	70,0	4872
	152	64,7		38,0	2459	60,8	3934	76,0	4917
	178	53,0		44,5	2359	71,2	3774	89,0	4717
	203	47,1		50,8	2391	81,2	3825	101,5	4781
	254	37,5		63,5	2382	101,6	3810	127,0	4763
	305	31,4		76,3	2395	122,0	3831	152,5	4789

FE 836 MB

 **FE 836 MB / 10 x 025**

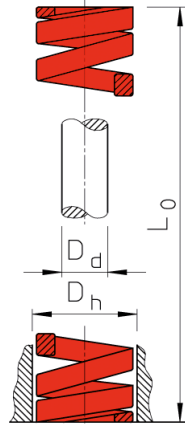

Dh mm	Lo mm	Dd mm	C N/mm	20% Arbeitsweg Working stroke		25% Arbeitsweg Working stroke		37% Arbeitsweg Working stroke	
				mm	N	mm	N	mm	N
10	025	5,0	17,8	5,0	89	6,3	111	9,3	165
	032		15,1	6,4	97	8,0	121	11,8	179
	038		13,2	7,6	101	9,5	126	14,1	186
	044		11,3	8,8	99	11,0	124	16,3	184
	051		8,4	10,2	86	12,8	107	18,9	159
	064		7,2	12,8	92	16,0	116	23,7	171
	076		5,8	15,2	88	19,0	110	28,1	163
	305		1,5	61,0	91	76,3	114	112,9	169
13	025	6,3	30,6	5,0	153	6,3	191	9,3	283
	032		22,0	6,4	141	8,0	176	11,8	261
	038		19,1	7,6	145	9,5	182	14,1	269
	044		16,1	8,8	142	11,0	177	16,3	262
	051		15,1	10,2	154	12,8	192	18,9	284
	064		11,8	12,8	151	16,0	189	23,7	280
	076		9,8	15,2	149	19,0	186	28,1	275
	089		8,1	17,8	144	22,3	180	32,9	266
	102		6,3	20,4	129	25,5	161	37,7	238
	305		2,1	61,0	128	76,3	160	112,9	237
16	025	8,0	57,1	5,0	285	6,3	357	9,3	528
	032		38,1	6,4	244	8,0	305	11,8	451
	038		33,4	7,6	254	9,5	318	14,1	470
	044		29,2	8,8	257	11,0	322	16,3	476
	051		25,5	10,2	261	12,8	326	18,9	482
	064		19,6	12,8	251	16,0	314	23,7	464
	076		16,2	15,2	246	19,0	307	28,1	455
	089		13,7	17,8	244	22,3	305	32,9	451
	102		12,7	20,4	259	25,5	324	37,7	479
	115		10,3	23,0	237	28,8	297	42,6	439
	305		3,9	61,0	238	76,3	297	112,9	440
	20		025	10,0	99,6	5,0	498	6,3	622
032		77,3	6,4		495	8,0	618	11,8	915
038		56,0	7,6		426	9,5	532	14,1	788
044		50,1	8,8		441	11,0	551	16,3	815
051		42,3	10,2		431	12,8	539	18,9	798
064		33,3	12,8		426	16,0	533	23,7	789
076		25,0	15,2		380	19,0	475	28,1	703
089		23,1	17,8		411	22,3	514	32,9	760
102		20,6	20,4		420	25,5	525	37,7	777
115		18,6	23,0		428	28,8	535	42,6	792
127		17,7	25,4		450	31,8	562	47,0	832
140		16,2	28,0		454	35,0	567	51,8	839
152		13,9	30,4		422	38,0	528	56,2	781
305		6,5	61,0		394	76,3	493	112,9	729
25	025	12,5	138,1	5,0	690	6,3	863	9,3	1277
	032		105,6	6,4	676	8,0	845	11,8	1250
	038		88,5	7,6	673	9,5	841	14,1	1245
	044		76,6	8,8	674	11,0	843	16,3	1247
	051		63,8	10,2	651	12,8	814	18,9	1204
	064		49,0	12,8	628	16,0	784	23,7	1161



Dh mm	Lo mm	Dd mm	C N/mm	20% Arbeitsweg Working stroke		25% Arbeitsweg Working stroke		37% Arbeitsweg Working stroke	
				mm	N	mm	N	mm	N
25	076	12,5	41,7	15,2	634	19,0	792	28,1	1172
	089		35,8	17,8	637	22,3	796	32,9	1178
	102		31,9	20,4	650	25,5	813	37,7	1203
	115		27,0	23,0	622	28,8	777	42,6	1150
	127		24,5	25,4	623	31,8	778	47,0	1152
	140		22,6	28,0	633	35,0	791	51,8	1171
	152		19,6	30,4	596	38,0	745	56,2	1102
	178		17,7	35,6	630	44,5	788	65,9	1166
	203		15,7	40,6	637	50,8	797	75,1	1179
	305		10,8	61,0	659	76,3	824	112,9	1219
32	038	16,0	196,7	7,6	1495	9,5	1868	14,1	2765
	044		176,7	8,8	1555	11,0	1944	16,3	2877
	051		147,3	10,2	1503	12,8	1878	18,9	2780
	064		108,0	12,8	1382	16,0	1728	23,7	2557
	076		90,1	15,2	1370	19,0	1713	28,1	2535
	089		74,4	17,8	1325	22,3	1656	32,9	2451
	102		64,6	20,4	1318	25,5	1648	37,7	2439
	115		56,0	23,0	1287	28,8	1609	42,6	2381
	127		47,1	25,4	1197	31,8	1496	47,0	2214
	140		44,1	28,0	1235	35,0	1543	51,8	2284
	152		40,7	30,4	1236	38,0	1545	56,2	2287
	178		34,3	35,6	1222	44,5	1527	65,9	2260
	203		31,4	40,6	1275	50,8	1593	75,1	2358
	254		22,1	50,8	1123	63,5	1403	94,0	2077
	305		20,6	61,0	1257	76,3	1572	112,9	2326
	40		051	20,0	178,8	10,2	1824	12,8	2280
064		132,5	12,8		1696	16,0	2120	23,7	3138
076		107,8	15,2		1639	19,0	2049	28,1	3032
089		94,0	17,8		1674	22,3	2092	32,9	3096
102		82,3	20,4		1679	25,5	2099	37,7	3106
115		73,8	23,0		1697	28,8	2122	42,6	3140
127		62,8	25,4		1596	31,8	1995	47,0	2952
140		58,8	28,0		1646	35,0	2058	51,8	3046
152		52,0	30,4		1579	38,0	1974	56,2	2922
178		44,1	35,6		1571	44,5	1964	65,9	2906
203		37,3	40,6		1514	50,8	1893	75,1	2801
254		31,4	50,8		1596	63,5	1995	94,0	2952
305		24,5	61,0		1495	76,3	1869	112,9	2766
50		064	25,0		211,0	12,8	2701	16,0	3376
	076	171,5		15,2	2606	19,0	3258	28,1	4822
	089	142,1		17,8	2529	22,3	3161	32,9	4678
	102	119,5		20,4	2437	25,5	3047	37,7	4509
	115	108,0		23,0	2485	28,8	3106	42,6	4597
	127	100,0		25,4	2541	31,8	3176	47,0	4700
	140	90,2		28,0	2525	35,0	3157	51,8	4672
	152	84,2		30,4	2561	38,0	3201	56,2	4738
	178	71,1		35,6	2532	44,5	3166	65,9	4685
	203	61,8		40,6	2509	50,8	3136	75,1	4641
	254	49,5		50,8	2515	63,5	3144	94,0	4653
	305	43,1		61,0	2630	76,3	3288	112,9	4866

FE 837 SB

 **FE 837 SB / 10 x 025**

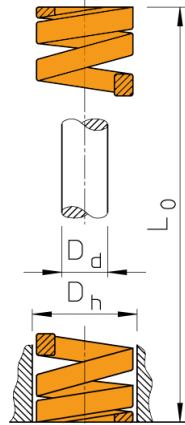

Dh mm	L0 mm	Dd mm	C N/mm	15% Arbeitsweg Working stroke		20% Arbeitsweg Working stroke		30% Arbeitsweg Working stroke	
				mm	N	mm	N	mm	N
10	025	5,0	22,5	3,8	85	5,0	113	7,5	169
	032		18,6	4,8	90	6,4	119	9,6	179
	038		15,9	5,7	91	7,6	121	11,4	181
	044		13,7	6,6	91	8,8	121	13,2	181
	051		11,8	7,7	90	10,2	120	15,3	180
	064		8,8	9,6	85	12,8	113	19,2	169
	076		6,4	11,4	73	15,2	97	22,8	146
	305		1,7	45,8	78	61,0	104	91,5	156
13	025	6,3	37,3	3,8	140	5,0	187	7,5	280
	032		32,5	4,8	156	6,4	208	9,6	312
	038		28,4	5,7	162	7,6	216	11,4	324
	044		24,5	6,6	162	8,8	215	13,2	323
	051		18,6	7,7	143	10,2	190	15,3	285
	064		15,7	9,6	151	12,8	201	19,2	301
	076		13,7	11,4	156	15,2	208	22,8	312
	089		10,8	13,4	144	17,8	192	26,7	288
	102		7,4	15,3	113	20,4	151	30,6	226
	305		3,1	45,8	142	61,0	189	91,5	284
16	025	8,0	78,3	3,8	294	5,0	391	7,5	587
	032		59,8	4,8	287	6,4	383	9,6	574
	038		51,0	5,7	291	7,6	387	11,4	581
	044		43,1	6,6	285	8,8	379	13,2	569
	051		38,2	7,7	292	10,2	389	15,3	584
	064		31,4	9,6	302	12,8	402	19,2	603
	076		24,5	11,4	280	15,2	373	22,8	559
	089		20,6	13,4	275	17,8	367	26,7	550
	102		18,6	15,3	285	20,4	379	30,6	569
	115		15,7	17,3	271	23,0	361	34,5	542
	305		5,7	45,8	261	61,0	348	91,5	522
	20		025	10,0	181,5	3,8	681	5,0	907
032		137,3	4,8		659	6,4	879	9,6	1318
038		107,9	5,7		615	7,6	820	11,4	1230
044		94,1	6,6		621	8,8	828	13,2	1242
051		78,5	7,7		601	10,2	801	15,3	1201
064		65,0	9,6		624	12,8	832	19,2	1248
076		56,9	11,4		649	15,2	865	22,8	1297
089		47,1	13,4		629	17,8	839	26,7	1258
102		41,2	15,3		631	20,4	841	30,6	1261
115		36,3	17,3		626	23,0	835	34,5	1252
127		32,4	19,1		617	25,4	823	38,1	1234
140		29,4	21,0		618	28,0	823	42,0	1235
152		25,5	22,8		582	30,4	775	45,6	1163
305		14,7	45,8		673	61,0	897	91,5	1345
25	025	12,5	333,5	3,8	1251	5,0	1667	7,5	2501
	032		257,4	4,8	1236	6,4	1647	9,6	2471
	038		210,8	5,7	1202	7,6	1602	11,4	2403
	044		176,5	6,6	1165	8,8	1553	13,2	2330
	051		148,1	7,7	1133	10,2	1511	15,3	2266
	064		119,6	9,6	1148	12,8	1531	19,2	2296



Dh mm	Lo mm	Dd mm	C N/mm	15% Arbeitsweg Working stroke		20% Arbeitsweg Working stroke		30% Arbeitsweg Working stroke	
				mm	N	mm	N	mm	N
25	076	12,5	100,0	11,4	1140	15,2	1520	22,8	2280
	089		83,4	13,4	1114	17,8	1485	26,7	2227
	102		73,6	15,3	1126	20,4	1501	30,6	2252
	115		63,7	17,3	1099	23,0	1465	34,5	2198
	127		56,9	19,1	1084	25,4	1445	38,1	2168
	140		51,0	21,0	1071	28,0	1428	42,0	2142
	152		47,1	22,8	1074	30,4	1432	45,6	2148
	178		41,2	26,7	1100	35,6	1467	53,4	2200
	203		36,3	30,5	1106	40,6	1474	60,9	2211
	305		22,6	45,8	1034	61,0	1379	91,5	2068
32	038	16,0	362,9	5,7	2069	7,6	2758	11,4	4137
	044		307,9	6,6	2032	8,8	2709	13,2	4064
	051		262,8	7,7	2011	10,2	2681	15,3	4021
	064		205,9	9,6	1977	12,8	2635	19,2	3953
	076		171,6	11,4	1956	15,2	2608	22,8	3912
	089		147,1	13,4	1964	17,8	2619	26,7	3928
	102		127,5	15,3	1951	20,4	2601	30,6	3902
	115		112,8	17,3	1946	23,0	2595	34,5	3892
	127		101,0	19,1	1924	25,4	2565	38,1	3848
	140		88,3	21,0	1855	28,0	2473	42,0	3709
	152		80,9	22,8	1845	30,4	2459	45,6	3689
	178		68,6	26,7	1832	35,6	2442	53,4	3663
	203		59,8	30,5	1821	40,6	2428	60,9	3642
	254		46,9	38,1	1787	50,8	2383	76,2	3574
	305		39,2	45,8	1794	61,0	2391	91,5	3587
	40		051	20,0	313,8	7,7	2401	10,2	3201
064		230,5	9,6		2213	12,8	2951	19,2	4426
076		196,1	11,4		2236	15,2	2981	22,8	4471
089		171,6	13,4		2291	17,8	3055	26,7	4582
102		142,2	15,3		2176	20,4	2901	30,6	4351
115		124,5	17,3		2148	23,0	2863	34,5	4295
127		112,8	19,1		2149	25,4	2865	38,1	4298
140		103,0	21,0		2163	28,0	2884	42,0	4326
152		93,2	22,8		2125	30,4	2833	45,6	4250
178		80,4	26,7		2147	35,6	2862	53,4	4293
203		70,6	30,5		2150	40,6	2867	60,9	4300
254		56,9	38,1		2168	50,8	2891	76,2	4336
305		47,1	45,8		2155	61,0	2873	91,5	4310
50		064	25,0		392,3	9,6	3766	12,8	5021
	076	328,5		11,4	3745	15,2	4993	22,8	7490
	089	274,6		13,4	3666	17,8	4888	26,7	7332
	102	235,4		15,3	3602	20,4	4802	30,6	7203
	115	205,9		17,3	3552	23,0	4736	34,5	7104
	127	186,3		19,1	3549	25,4	4732	38,1	7098
	140	166,7		21,0	3501	28,0	4667	42,0	7001
	152	147,1		22,8	3354	30,4	4472	45,6	6708
	178	127,5		26,7	3405	35,6	4539	53,4	6809
	203	112,8		30,5	3435	40,6	4580	60,9	6870
	254	88,3		38,1	3364	50,8	4485	76,2	6728
	305	70,6		45,8	3230	61,0	4307	91,5	6460

FE 838 BB

FE 838 BB / 10 x 025

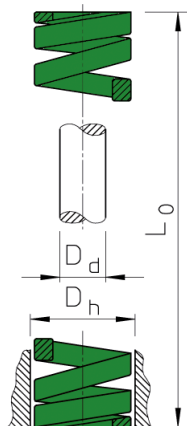

Dh mm	Lo mm	Dd mm	C N/mm	15% Arbeitsweg Working stroke		20% Arbeitsweg Working stroke		25% Arbeitsweg Working stroke	
				mm	N	mm	N	mm	N
10	025	5,0	38,9	3,8	146	5,0	194	6,3	243
	032		29,8	4,8	143	6,4	190	8,0	238
	038		25,4	5,7	145	7,6	193	9,5	241
	044		20,2	6,6	133	8,8	178	11,0	222
	051		17,6	7,7	135	10,2	180	12,8	225
	064		14,0	9,6	134	12,8	179	16,0	224
	076		11,4	11,4	130	15,2	174	19,0	217
	305		2,6	45,8	119	61,0	158	76,3	198
13	025	6,3	56,5	3,8	212	5,0	282	6,3	353
	032		42,1	4,8	202	6,4	270	8,0	337
	038		35,1	5,7	200	7,6	266	9,5	333
	044		29,8	6,6	197	8,8	262	11,0	328
	051		24,6	7,7	188	10,2	251	12,8	314
	064		20,2	9,6	194	12,8	258	16,0	323
	076		15,8	11,4	180	15,2	240	19,0	300
	089		14,0	13,4	187	17,8	250	22,3	312
	102		10,8	15,3	165	20,4	220	25,5	275
	305		4,4	45,8	202	61,0	269	76,3	336
16	025	8,0	111,2	3,8	417	5,0	556	6,3	695
	032		82,3	4,8	395	6,4	526	8,0	658
	038		66,7	5,7	380	7,6	507	9,5	634
	044		56,1	6,6	370	8,8	494	11,0	617
	051		51,0	7,7	390	10,2	520	12,8	650
	064		38,5	9,6	370	12,8	493	16,0	616
	076		31,5	11,4	359	15,2	479	19,0	599
	089		28,0	13,4	374	17,8	499	22,3	624
	102		23,6	15,3	361	20,4	482	25,5	602
	115		20,6	17,3	356	23,0	474	28,8	593
	305		7,8	45,8	357	61,0	476	76,3	595
	20		025	10,0	207,5	3,8	778	5,0	1038
032		166,8	4,8		800	6,4	1067	8,0	1334
038		132,4	5,7		755	7,6	1006	9,5	1258
044		117,7	6,6		777	8,8	1036	11,0	1295
051		98,5	7,7		754	10,2	1005	12,8	1256
064		83,4	9,6		800	12,8	1067	16,0	1334
076		68,6	11,4		782	15,2	1042	19,0	1303
089		55,0	13,4		734	17,8	979	22,3	1224
102		48,1	15,3		736	20,4	982	25,5	1227
115		41,3	17,3		712	23,0	950	28,8	1187
127		38,3	19,1		729	25,4	972	31,8	1215
140		33,3	21,0		700	28,0	933	35,0	1166
152		31,4	22,8		716	30,4	954	38,0	1193
305		16,5	45,8		755	61,0	1007	76,3	1259
25	025	12,5	444,8	3,8	1668	5,0	2224	6,3	2780
	032		343,3	4,8	1648	6,4	2197	8,0	2746
	038		323,6	5,7	1844	7,6	2459	9,5	3074
	044		264,8	6,6	1748	8,8	2330	11,0	2913
	051		201,8	7,7	1544	10,2	2058	12,8	2573
	064		156,9	9,6	1506	12,8	2008	16,0	2510



Dh mm	L0 mm	Dd mm	C N/mm	15% Arbeitsweg Working stroke		20% Arbeitsweg Working stroke		25% Arbeitsweg Working stroke	
				mm	N	mm	N	mm	N
25	076	12,5	127,5	11,4	1454	15,2	1938	19,0	2423
	089		108,1	13,4	1444	17,8	1925	22,3	2406
	102		96,1	15,3	1471	20,4	1961	25,5	2451
	115		84,5	17,3	1457	23,0	1942	28,8	2428
	127		75,6	19,1	1441	25,4	1921	31,8	2401
	140		63,7	21,0	1338	28,0	1784	35,0	2230
	152		62,8	22,8	1432	30,4	1909	38,0	2386
	178		53,9	26,7	1439	35,6	1919	44,5	2399
	203		46,1	30,5	1405	40,6	1874	50,8	2342
	305		33,3	45,8	1525	61,0	2033	76,3	2541
32	038	16,0	470,7	5,7	2683	7,6	3578	9,5	4472
	044		392,3	6,6	2589	8,8	3452	11,0	4315
	051		334,7	7,7	2561	10,2	3414	12,8	4268
	064		264,8	9,6	2542	12,8	3390	16,0	4237
	076		215,6	11,4	2458	15,2	3277	19,0	4096
	089		167,1	13,4	2230	17,8	2974	22,3	3717
	102		147,1	15,3	2251	20,4	3001	25,5	3751
	115		137,5	17,3	2372	23,0	3163	28,8	3954
	127		127,7	19,1	2433	25,4	3244	31,8	4055
	140		112,8	21,0	2369	28,0	3158	35,0	3948
	152		103,0	22,8	2348	30,4	3131	38,0	3914
	178		92,2	26,7	2462	35,6	3282	44,5	4103
	203		75,6	30,5	2301	40,6	3068	50,8	3835
	254		60,8	38,1	2317	50,8	3089	63,5	3861
	305		49,0	45,8	2243	61,0	2991	76,3	3739
	40		051	20,0	541,5	7,7	4142	10,2	5523
064		460,9	9,6		4424	12,8	5899	16,0	7374
076		353,0	11,4		4024	15,2	5366	19,0	6707
089		294,9	13,4		3937	17,8	5249	22,3	6561
102		255,0	15,3		3902	20,4	5202	25,5	6503
115		226,0	17,3		3898	23,0	5198	28,8	6497
127		201,3	19,1		3835	25,4	5114	31,8	6392
140		186,3	21,0		3913	28,0	5217	35,0	6521
152		166,7	22,8		3801	30,4	5068	38,0	6335
178		147,1	26,7		3928	35,6	5237	44,5	6546
203		127,6	30,5		3886	40,6	5182	50,8	6477
254		98,1	38,1		3737	50,8	4983	63,5	6229
305		83,4	45,8		3818	61,0	5090	76,3	6363
50		064	25,0		645,3	9,6	6195	12,8	8260
	076	554,1		11,4	6317	15,2	8422	19,0	10528
	089	452,1		13,4	6036	17,8	8048	22,3	10060
	102	402,1		15,3	6152	20,4	8203	25,5	10254
	115	343,8		17,3	5930	23,0	7907	28,8	9884
	127	314,3		19,1	5987	25,4	7983	31,8	9979
	140	284,4		21,0	5972	28,0	7963	35,0	9954
	152	264,8		22,8	6037	30,4	8050	38,0	10062
	178	225,6		26,7	6023	35,6	8031	44,5	10039
	203	193,9		30,5	5904	40,6	7872	50,8	9840
	254	153,0		38,1	5830	50,8	7773	63,5	9716
	305	146,2		45,8	6688	61,0	8918	76,3	11147

FE 802

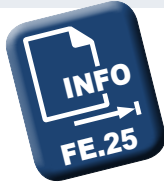

Mat.: Elastomere / Ultraflex 92
Härte: 92 ±5 Shore

Elastomer-Federn haben eine Setz-
neigung, die abhängig vom Wärme,
Federweg und Hubgeschwindigkeit
ist. Sie beträgt ca. 5-8% der Feder-
länge L₀.

Mat.: Elastomer / Ultraflex 92
Hardness: 92 ±5 Shore

Elastomer springs do have a settling
characteristic of around 5-8 % of
the initial total length L₀, depending
on temperature, stroke length and
speed.

FE 802 / 040 x 32

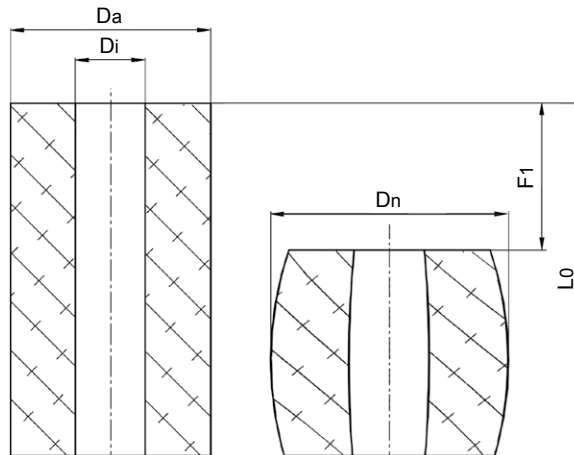

Da	L ₀	Di	D _n	F _{max.} mm
016	16	6,5	21	4,8
	20	6,5	21	6,0
	25	6,5	21	7,5
	32	6,5	21	9,6
020	16	8,5	26	4,8
	20	8,5	26	6,0
	25	8,5	26	7,5
	32	8,5	26	9,6
025	40	8,5	26	12,0
	16	10,5	33	4,8
	20	10,5	33	6,0
	25	10,5	33	7,5
	32	10,5	33	9,6
032	40	10,5	33	12,0
	50	10,5	33	15,0
	16	13,5	42	4,8
	20	13,5	42	6,0
	25	13,5	42	7,5
	32	13,5	42	9,6
040	40	13,5	42	12,0
	50	13,5	42	15,0
	63	13,5	42	18,9
	80	13,5	42	24,0
	16	13,5	52	4,8
	20	13,5	52	6,0
040	25	13,5	52	7,5
	32	13,5	52	9,6
	40	13,5	52	12,0
	50	13,5	52	15,0
	63	13,5	52	18,9
	80	13,5	52	24,0

Da	L ₀	Di	D _n	F _{max.} mm
050	25	17,0	65	7,5
	32	17,0	65	9,6
	40	17,0	65	12,0
	50	17,0	65	15,0
	63	17,0	65	18,9
	80	17,0	65	24,0
063	100	17,0	65	30,0
	32	17,0	82	9,6
	40	17,0	82	12,0
	50	17,0	82	15,0
080	63	17,0	82	18,9
	80	17,0	82	24,0
	100	17,0	82	30,0
	32	21,0	104	9,6
100	40	21,0	104	12,0
	50	21,0	104	15,0
	63	21,0	104	18,9
	80	21,0	104	24,0
125	100	21,0	104	30,0
	50	21,0	130	15,0
	63	21,0	130	18,9
	80	21,0	130	24,0
125	100	21,0	130	30,0
	50	27,0	160	15,0
	63	27,0	160	18,9
	80	27,0	160	24,0
125	100	27,0	160	30,0

[FE]



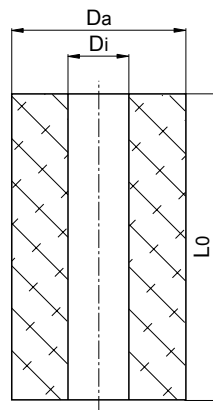

FE 804

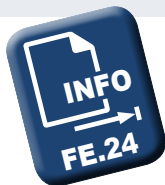

Mat.: Elastomere / Ultraflex
Härte: 82 Shore

Mat.: Elastomer / Ultraflex
Hardness: 82 Shore

FE 804 / 016

Kennfarbe gelb

Color code yellow

Da	Di	L0
016	7	250
020	9	250
025	11	250
032	14	500
040	14	500
050	17	500
063	17	500
080	21	500
100	21	500
125	27	500



FE 805

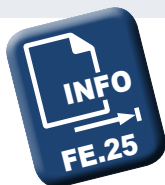

Mat.: Elastomere / Ultraflex
Härte: 92 Shore

Mat.: Elastomer / Ultraflex
Hardness: 92 Shore

FE 805 / 025

Kennfarbe rot

Color code red

Da	Di	L0
016	7	250
020	9	250
025	11	250
032	14	500
040	14	500
050	17	500
063	17	500
080	21	500
100	21	500
125	27	500



FE 806

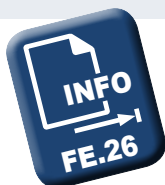

Mat.: Elastomere / Ultraflex
Härte: 94 Shore

Mat.: Elastomer / Ultraflex
Hardness: 94 Shore

FE 806 / 040

Kennfarbe grün

Color code green

Da	Di	L0
016	7	250
020	9	250
025	11	250
032	14	500
040	14	500
050	17	500
063	17	500
080	21	500
100	21	500
125	27	500



FE 816

Mat.: C15

Mat.: C15

FE 816 / 06 x 020

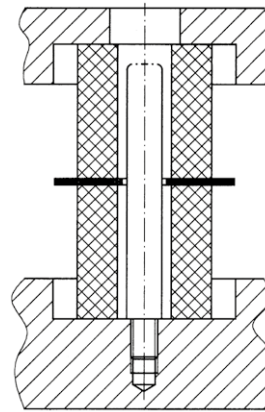
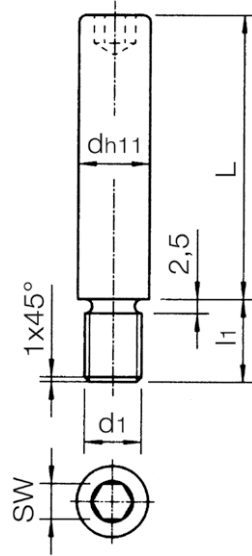

d	d1	l1	SW	E +0,1											
				020	025	032	040	050	063	080	095	118	140	180	
06	M4	6	3	•	•	•									
08	M6	9	4	•	•	•	•	•							
10	M8	15	5	•	•	•	•	•	•						
13	M10	15	6			•	•	•	•	•	•				
16	M12	18	8			•	•	•	•	•	•	•	•		
20	M16	25	10			•	•	•	•	•	•	•	•	•	
25	M20	30	14			•	•	•	•	•	•	•	•	•	•

Federteller nach DIN ISO 10069-2 für Elastomerfedern

Spring washers, DIN ISO 10069-2 for elastomer - springs

FE 815

Mat.: MS 58

Mat.: MS 58

FE 815 / 016

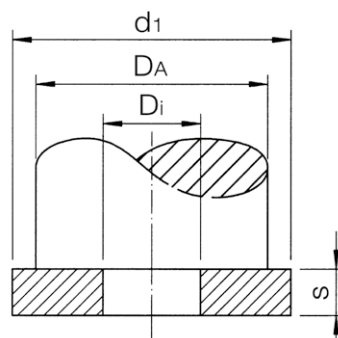

DA	d1	Di	s
016	20	6,5	4
020	25	8,5	4
025	30	10,5	5
032	40	13,5	5
040	50	13,5	5
050	60	16,5	6
063	80	16,5	6
080	100	20,5	8
100	120	20,5	8
125	150	26,0	8



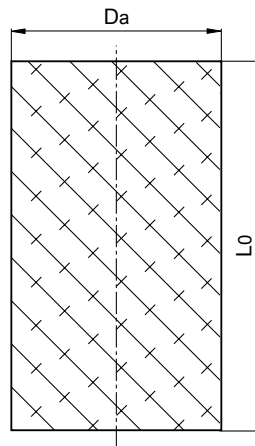

FE 807

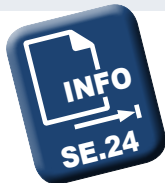

Mat.: Elastomere / Ultraflex
Härte: 82 Shore

Mat.: Elastomer / Ultraflex
Hardness: 82 Shore

FE 807 / 016

Kennfarbe gelb

Color code yellow

Da	Lo
016	250
020	250
025	250
032	500
040	500
050	500
063	500
080	500
100	500
125	500



FE 808



Mat.: Elastomere / Ultraflex
Härte: 92 Shore

Mat.: Elastomer / Ultraflex
Hardness: 92 Shore

FE 808 / 025

Color code red

Da	Lo
016	250
020	250
025	250
032	500
040	500
050	500
063	500
080	500
100	500
125	500



FE 809

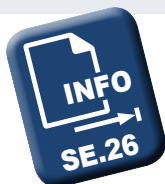

Mat.: Elastomere / Ultraflex
Härte: 94 Shore

Mat.: Elastomer / Ultraflex
Hardness: 94 Shore

FE 809 / 040

Kennfarbe grün

Color code green

Da	Lo
016	250
020	250
025	250
032	500
040	500
050	500
063	500
080	500
100	500
125	500



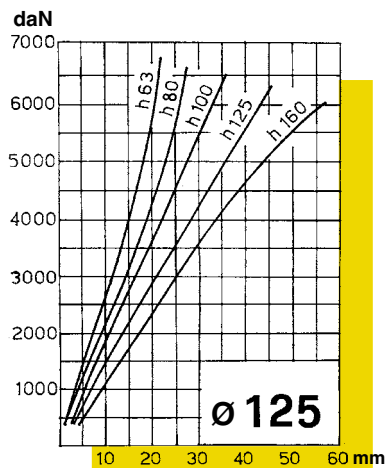
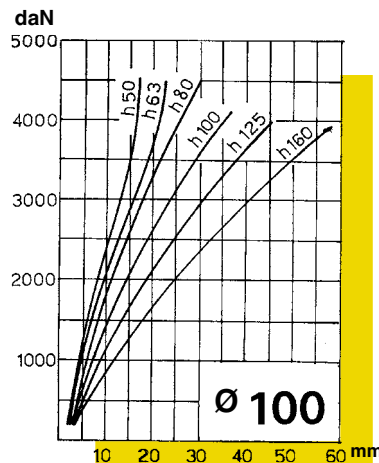
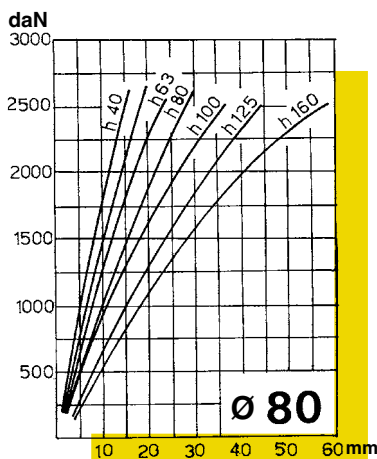
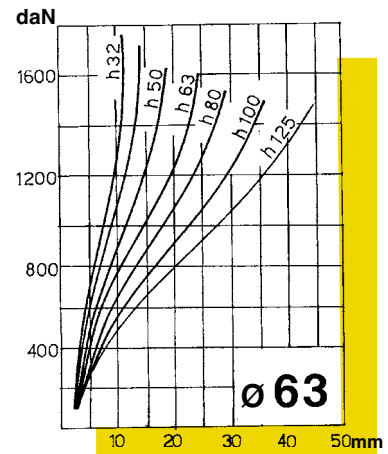
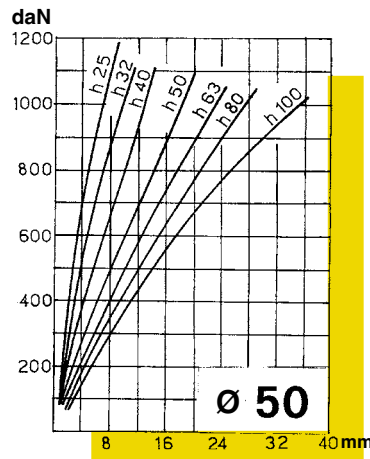
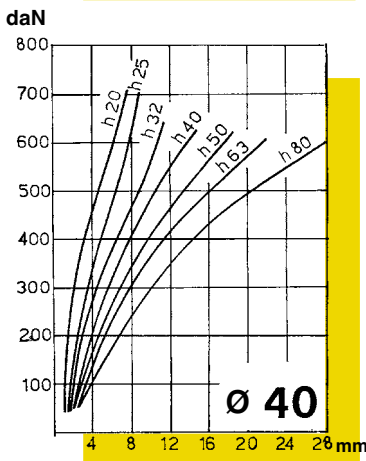
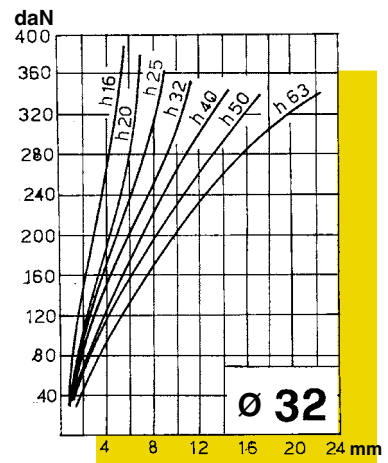
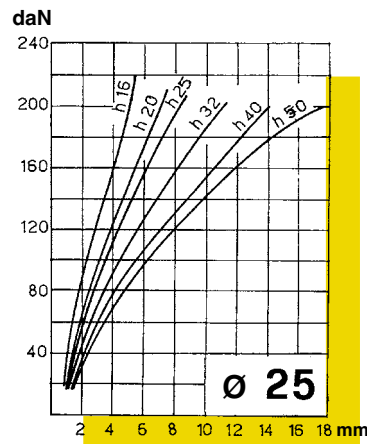
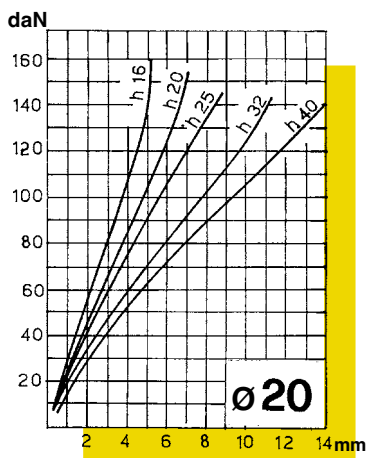
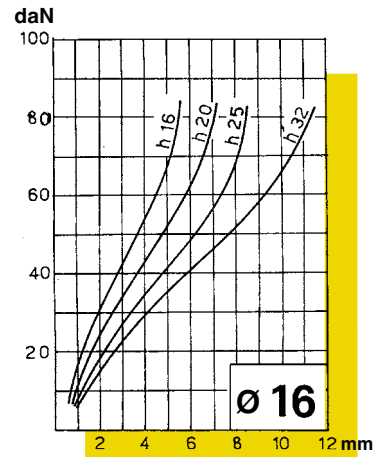

[FE]



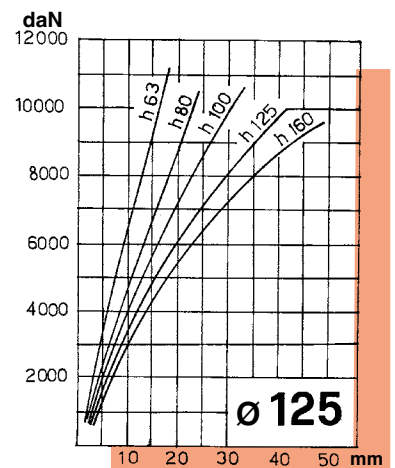
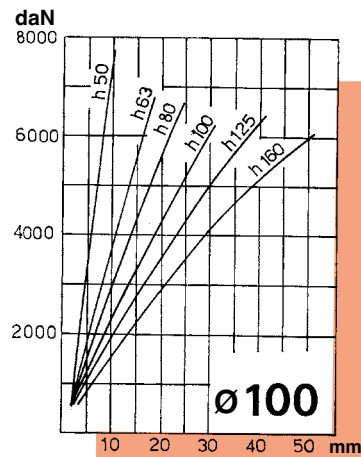
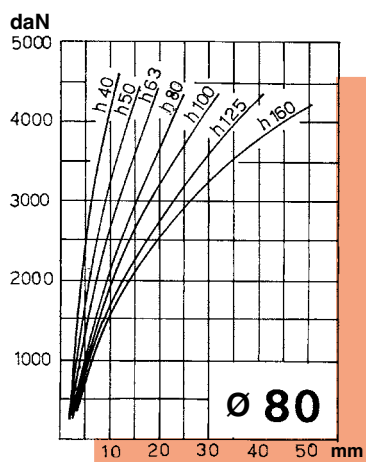
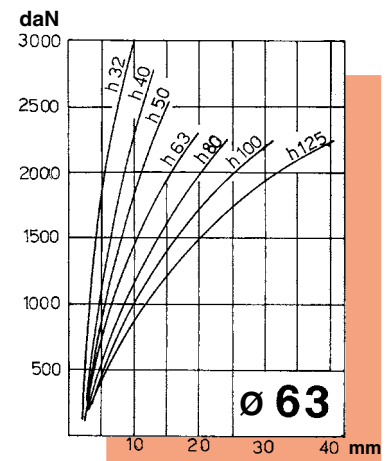
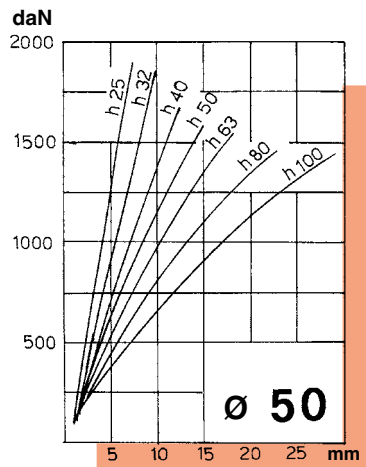
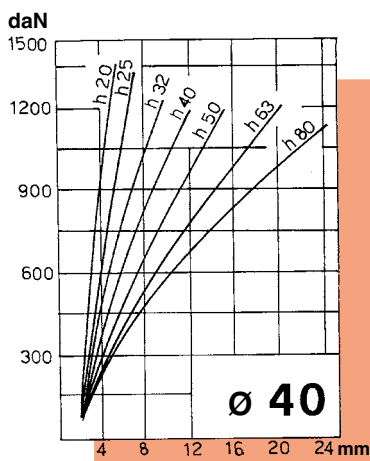
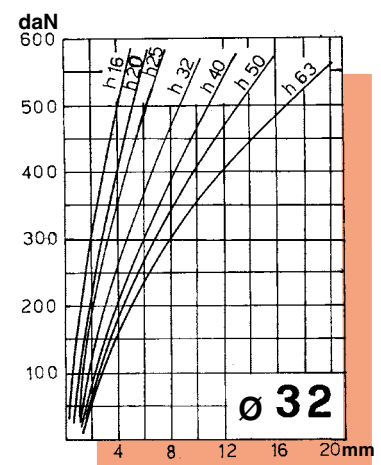
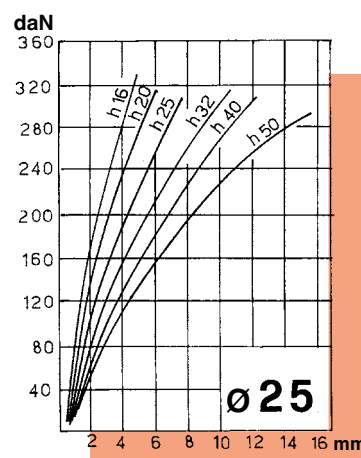
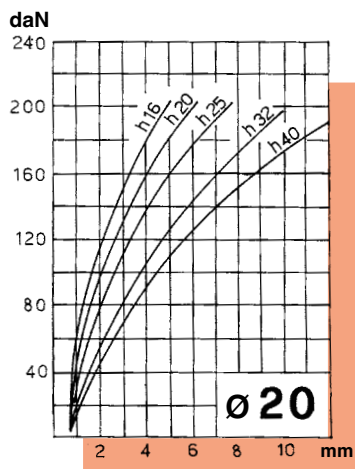
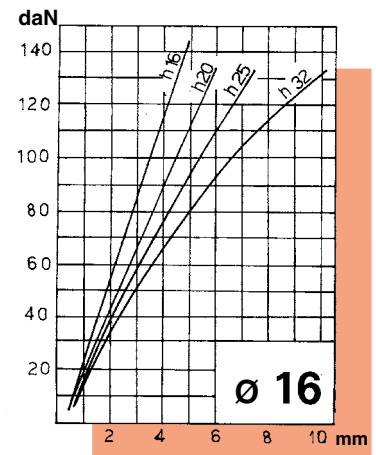

[FE]

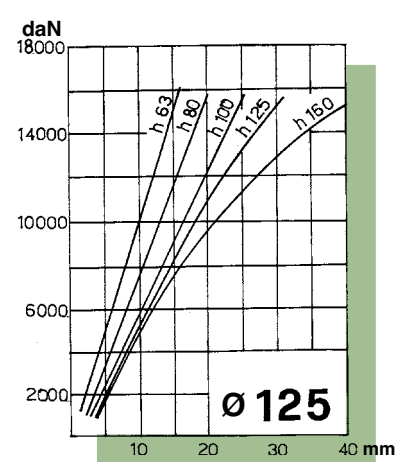
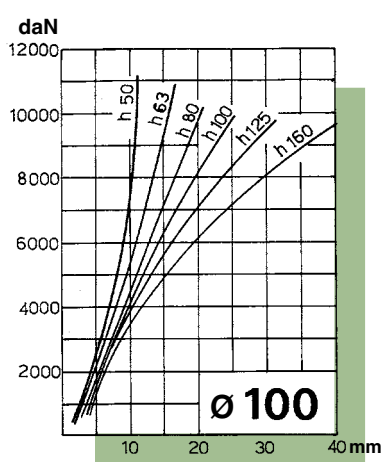
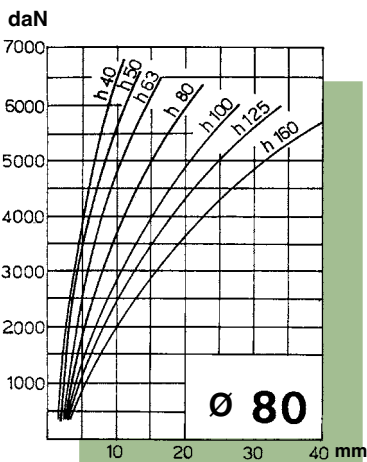
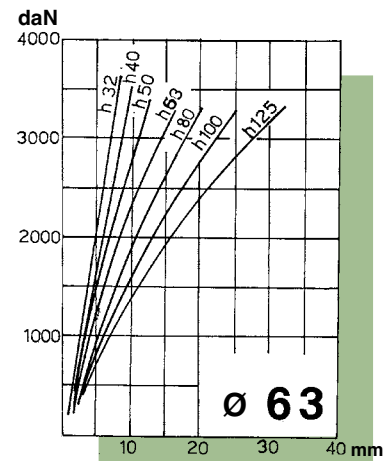
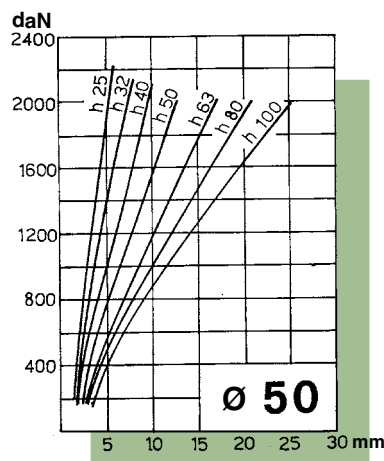
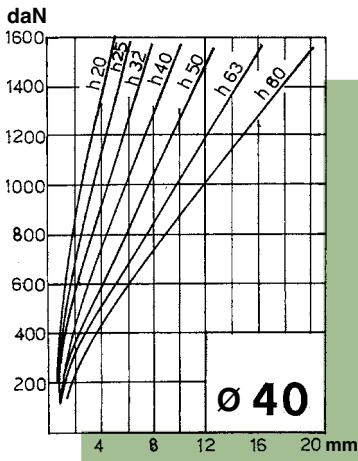
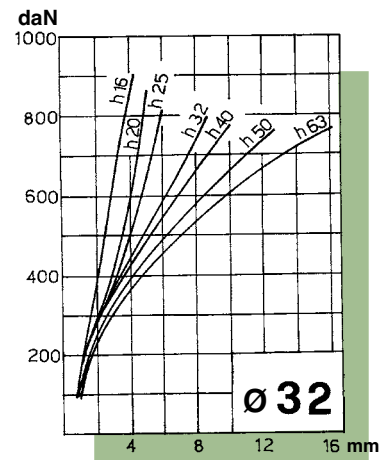
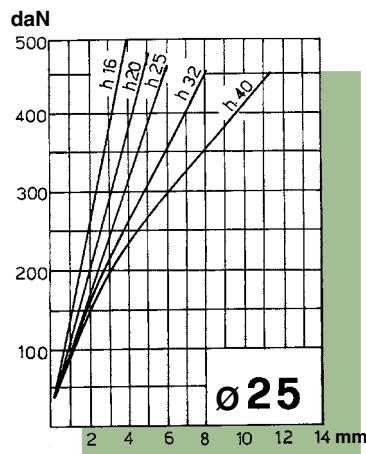
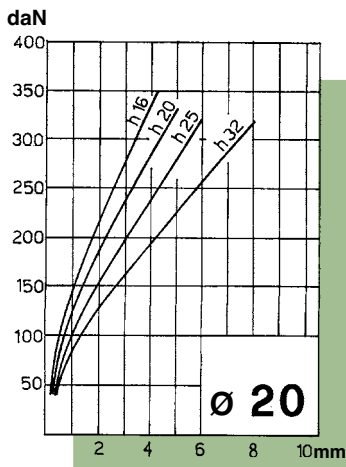
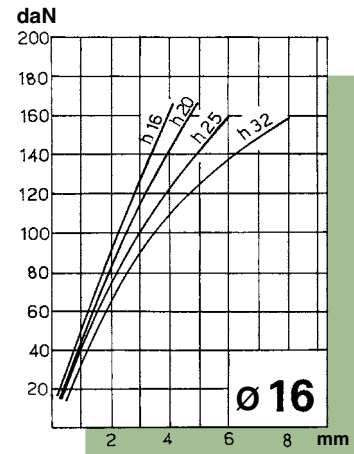

[FE]

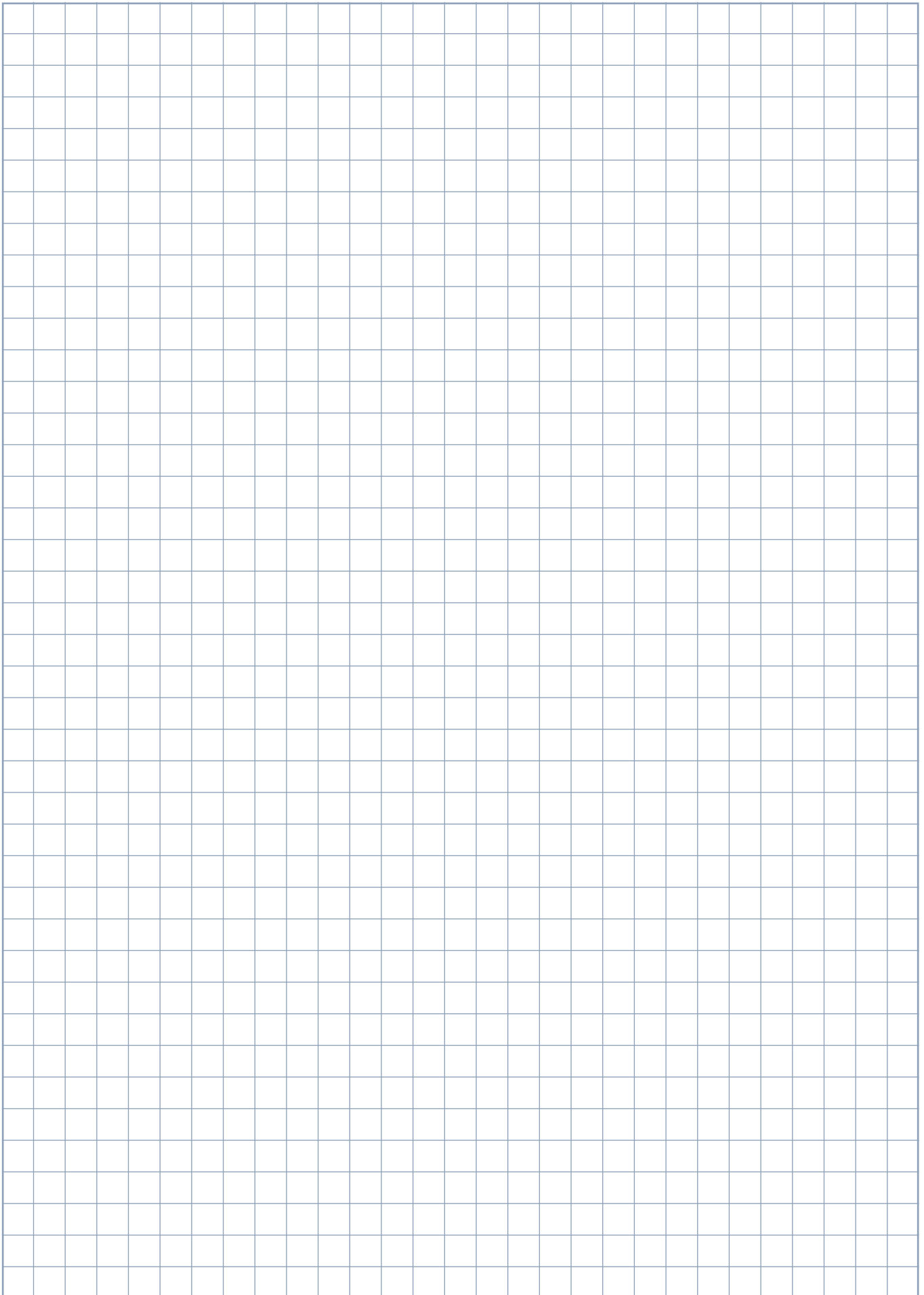

A large, empty grid area for taking notes, consisting of a uniform pattern of small squares. The grid is bounded by a thin blue line on the top, left, and right sides, and a thicker blue line on the bottom side. The grid covers most of the page area below the header.

