

DATI 1400

Kennzeichnungsstempel mit Schnellwechselsystem Ø 2,6 – 16 mm
mit Höhenverstellung, kurzer Typ, mit Befestigungsgewinde
*Identification stamp with fast-change system Ø 2,6 – 16 mm
with height adjustment, short version, with fastening thread*

**Kennzeichnungsstempel mit Schnellwechselsystem Ø 2,6 – 16 mm
mit Höhenverstellung, kurzer Typ, mit Befestigungsgewinde**
*Identification stamp with fast-change system Ø 2,6 – 16 mm
with height adjustment, short version, with fastening thread*

DATI®-BESCHREIBUNG DATI®-DESCRIPTION



- Hülse mit Kennzeichnung
- Stelleinsatz mit Anzeigepfeil. Der vertiefte Anzeigepfeil dient als Schraubslitz zur Einstellung und zum Einsatzwechsel
- Befestigungsgewinde
- Druckfeder zum stufenlosen Arretieren des Stelleinsatzes
- Werkstoff für Hülse und Stelleinsatz: 1.4034, gehärtet HRC 56 ± 2 rostfrei
- Beschriftung spiegelbildlich
- Sleeve with identifier
- Adjustable insert with indicator arrow
- The recessed indicator arrow is used as a screw slot for the adjustment and to change the insert
- Fastening thread
- Compression spring for the infinite locking of the adjustable insert
- Material for sleeve and adjustable insert: 1.4034, hardened HRC 56 ± 2 stainless
- Inscription laterally reversed

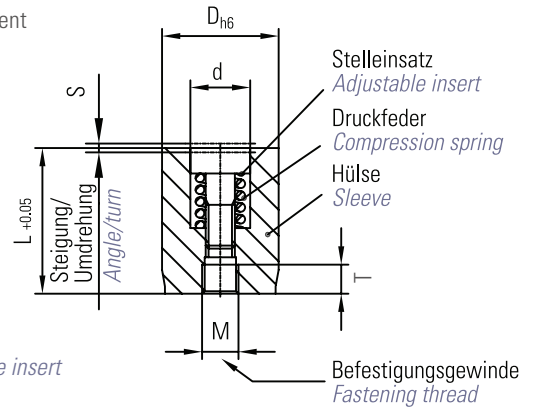

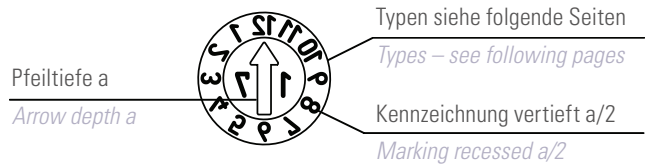
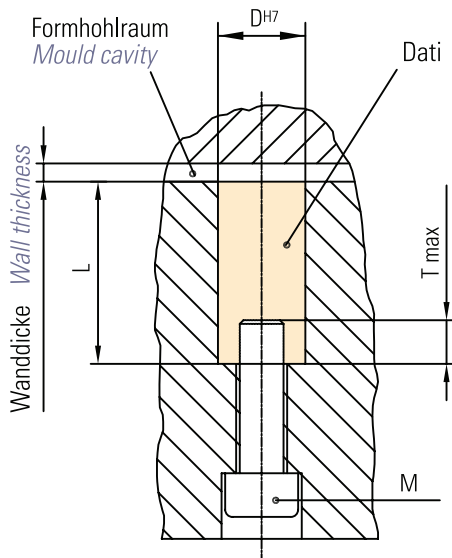

Montage Installation



Maßtabelle in mm Dimension table in mm						
D	d	L	M	T	a	S
2,6	1,4	7	1,6	2	0,20	0,20
2,8	1,4	7	1,6	2	0,20	0,20
3	1,5	7	2	2	0,20	0,20
3,5	1,8	8	2	2	0,20	0,25
4	2,1	8	2	2	0,30	0,25
5	3,1	12	3	3	0,40	0,20
6	3,1	12	3	3	0,40	0,20
8	4,4	14	4	3	0,40	0,25
10	5,2	16	4	3	0,40	0,35
12	6,2	20	5	4	0,60	0,35
16	8,2	20	5	4	0,60	0,35

SNELLWECHSELSYSTEM FAST CHANGING SYSTEM

			Der Stelleinsatz mit Jahreszahl wird zum Jahreswechsel durch Aus- und Eindrehen in Sekundenschnelle gewechselt. - Fertigung unterbrechen, Form öffnen - Stelleinsatz wechseln, Zeitraum einstellen - Fertigung fortsetzen - Kontrolle der Einstellung am Spritzteil <i>At the end of each year, the adjustable insert with year is changed in a matter of seconds by removing and screwing it in.</i> - Stop production, open mould - Change adjustable insert, set date - Continue production - Check setting on moulded part
<p>Stelleinsatz eindrehen:</p> <ul style="list-style-type: none"> • Rechts drehen • Nach Augenmaß auf Höhe einstellen <p><i>To screw in adjustable insert:</i></p> <ul style="list-style-type: none"> • Turn clockwise • Adjust height according to visual estimate 	<p>Stelleinsatz verdrehen:</p> <ul style="list-style-type: none"> • Rechts oder links einstellen • Auf Höhenverstellung achten <p><i>To turn adjustable insert:</i></p> <ul style="list-style-type: none"> • Turn clockwise or counter-clockwise • Check height adjustment 	<p>Stelleinsatz wechseln:</p> <ul style="list-style-type: none"> • Kontinuierlich nach links drehen • Stelleinsatz hebt sich • Stelleinsatz entnehmen <p><i>To change adjustable insert:</i></p> <ul style="list-style-type: none"> • Turn continuously counter-clockwise • The adjustable insert will raise • Remove adjustable insert 	

DATI 1400

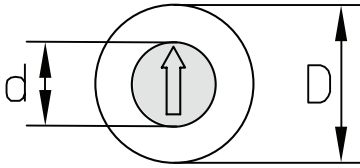

Maßstabelle in mm Dimension table in mm



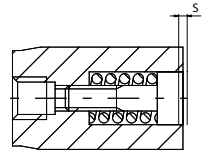

D	2,6	2,8	3	3,5	4	5	6	8	10	12	16	mm
d	1,4	1,4	1,5	1,8	2,1	3,1	3,1	4,4	5,2	6,2	8,2	mm

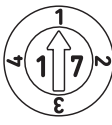

Typ Type	A		B		C		CC	
							6 Jahre 6 Years	
Anzeige Indicator	Monate + Jahr (z. B. Dez. 17) <i>Months + year (e.g. dec. 17)</i>		Monate (z. B. Dez.) kombinierbar mit Typ C (zeigt z. B. Dez. 17) <i>Months (e.g. dec.) connected with type C (displays e.g. dec. 17)</i>		Jahr + 5 Jahre kombinierbar mit Typ B (zeigt z. B. Dez. 17) <i>Year + 5 years connected with type B (displays e.g. dec. 17)</i>		Jahr + 11 Jahre kombinierbar mit Typ B (zeigt z. B. Dez. 17) <i>Year + 11 years connected with type B (displays e.g. dec. 17)</i>	
D	Bestell-Nr. Order no.	Euro	Bestell-Nr. Order no.	Euro	Bestell-Nr. Order no.	Euro	Bestell-Nr. Order no.	Euro
2,6	A/1402,6/Jahr(Year)	30,00	B/1402,6/00	30,00	C/1402,6/Jahr(Year)+5	30,00	CC/1402,6/Jahr(Year)+11	30,00
2,8	A/1402,8/Jahr(Year)	30,00	B/1402,8/00	30,00	C/1402,8/Jahr(Year)+5	30,00	CC/1402,8/Jahr(Year)+11	30,00
3	A/1403/Jahr(Year)	30,00	B/1403/00	30,00	C/1403/Jahr(Year)+5	30,00	CC/1403/Jahr(Year)+11	30,00
3,5	A/1403,5/Jahr(Year)	30,00	B/1403,5/00	30,00	C/1403,5/Jahr(Year)+5	30,00	CC/1403,5/Jahr(Year)+11	30,00
4	A/1404/Jahr(Year)	30,00	B/1404/00	30,00	C/1404/Jahr(Year)+5	30,00	CC/1404/Jahr(Year)+11	30,00
5	A/1405/Jahr(Year)	27,00	B/1405/00	27,00	C/1405/Jahr(Year)+5	27,00	CC/1405/Jahr(Year)+11	27,00
6	A/1406/Jahr(Year)	27,00	B/1406/00	27,00	C/1406/Jahr(Year)+5	27,00	CC/1406/Jahr(Year)+11	27,00
8	A/1408/Jahr(Year)	27,00	B/1408/00	27,00	C/1408/Jahr(Year)+5	27,00	CC/1408/Jahr(Year)+11	27,00
10	A/1410/Jahr(Year)	27,00	B/1410/00	27,00	C/1410/Jahr(Year)+5	27,00	CC/1410/Jahr(Year)+11	27,00
12	A/1412/Jahr(Year)	32,00	B/1412/00	32,00	C/1412/Jahr(Year)+5	32,00	CC/1412/Jahr(Year)+11	32,00
16	A/1416/Jahr(Year)	32,00	B/1416/00	32,00	C/1416/Jahr(Year)+5	32,00	CC/1416/Jahr(Year)+11	32,00

Typ Type	D + E		H + I		L + E		J	
							12 x Monat 01 ... 12 12 x month 01 ... 12	
Anzeige Indicator	Woche + Jahr (z. B. ergibt die Kombina- tion aus den Zahlen 30 + 5: Kw 35/17) <i>Week + year (e.g. the combination of the numbers 30 and 5 results in 30 + 5: calendar week 35/17)</i>		Tage (z. B. 20 + 9 = 29) kombinierbar mit Typ A (zeigt z. B. 29. Dez. 17) <i>Days (e.g. 20 + 9 = 29) connected with type A (displays e.g. 29. dec. 17)</i>		Tage + Monate + Jahr (z. B. 25. Mai 17) <i>Days + month + year (e.g. 25. may 17)</i>		Schichtzahlen (z. B. 2. Schicht) <i>Shift numbers (e.g. 2nd shift)</i>	
D	Bestell-Nr. Order no.	Euro	Bestell-Nr. Order no.	Euro	Bestell-Nr. Order no.	Euro	Bestell-Nr. Order no.	Euro
2,6	D+E/1402,6/Jahr(Year)	60,00	H+I/1402,6/00	60,00	L+E/1402,6/Jahr(Year)	104,00	J/1402,6/00	30,00
2,8	D+E/1402,8/Jahr(Year)	60,00	H+I/1402,8/00	60,00	L+E/1402,8/Jahr(Year)	104,00	J/1402,8/00	30,00
3	D+E/1403/Jahr(Year)	60,00	H+I/1403/00	60,00	L+E/1403/Jahr(Year)	104,00	J/1403/00	30,00
3,5	D+E/1403,5/Jahr(Year)	60,00	H+I/1403,5/00	60,00	L+E/1403,5/Jahr(Year)	104,00	J/1403,5/00	30,00
4	D+E/1404/Jahr(Year)	60,00	H+I/1404/00	60,00	L+E/1404/Jahr(Year)	104,00	J/1404/00	30,00
5	D+E/1405/Jahr(Year)	54,00	H+I/1405/00	54,00	L+E/1405/Jahr(Year)	98,00	J/1405/00	27,00
6	D+E/1406/Jahr(Year)	54,00	H+I/1406/00	54,00	L+E/1406/Jahr(Year)	98,00	J/1406/00	27,00
8	D+E/1408/Jahr(Year)	54,00	H+I/1408/00	54,00	L+E/1408/Jahr(Year)	98,00	J/1408/00	27,00
10	D+E/1410/Jahr(Year)	54,00	H+I/1410/00	54,00	L+E/1410/Jahr(Year)	98,00	J/1410/00	27,00
12	D+E/1412/Jahr(Year)	64,00	H+I/1412/00	64,00	L+E/1412/Jahr(Year)	130,00	J/1412/00	32,00
16	D+E/1416/Jahr(Year)	64,00	H+I/1416/00	64,00	L+E/1416/Jahr(Year)	130,00	J/1416/00	32,00

**Kennzeichnungsstempel mit Schnellwechselsystem Ø 2,6 – 16 mm
mit Höhenverstellung, kurzer Typ, mit Befestigungsgewinde**
*Identification stamp with fast-change system Ø 2,6 – 16 mm
with height adjustment, short version, with fastening thread*

Typ Type	K		M		N		R	
								
Anzeige Indicator	Quartal + Jahr (z. B. 1. Quartal 17) <i>Quarter + year (e.g. 1. quarter 17)</i>		Kennbuchstaben A – M (Typ M) <i>Identifier letters A – M (type M)</i>		Kennbuchstaben N – Z (Typ N) <i>Identifier letters N – Z (type N)</i>		Kennzeichnung nach Wunsch z. B. Materialkennzeichnung <i>Identification according to customers preference e.g. material identification</i>	
D	Bestell-Nr. Order no.	Euro	Bestell-Nr. Order no.	Euro	Bestell-Nr. Order no.	Euro	Bestell-Nr. Order no.	Euro
2,6	K/1402,6/Jahr(Year)	30,00	M/1402,6/00	30,00	N/1402,6/00	30,00	R/1402,6/Zeichen(Symbol)	35,00
2,8	K/1402,8/Jahr(Year)	30,00	M/1402,8/00	30,00	N/1402,8/00	30,00	R/1402,8/Zeichen(Symbol)	35,00
3	K/1403/Jahr(Year)	30,00	M/1403/00	30,00	N/1403/00	30,00	R/1403/Zeichen(Symbol)	35,00
3,5	K/1403,5/Jahr(Year)	30,00	M/1403,5/00	30,00	N/1403,5/00	30,00	R/1403,5/Zeichen(Symbol)	35,00
4	K/1404/Jahr(Year)	30,00	M/1404/00	30,00	N/1404/00	30,00	R/1404/Zeichen(Symbol)	35,00
5	K/1405/Jahr(Year)	27,00	M/1405/00	27,00	N/1405/00	27,00	R/1405/Zeichen(Symbol)	32,00
6	K/1406/Jahr(Year)	27,00	M/1406/00	27,00	N/1406/00	27,00	R/1406/Zeichen(Symbol)	32,00
8	K/1408/Jahr(Year)	27,00	M/1408/00	27,00	N/1408/00	27,00	R/1408/Zeichen(Symbol)	32,00
10	K/1410/Jahr(Year)	27,00	M/1410/00	27,00	N/1410/00	27,00	R/1410/Zeichen(Symbol)	32,00
12	K/1412/Jahr(Year)	32,00	M/1412/00	32,00	N/1412/00	32,00	R/1412/Zeichen(Symbol)	37,00
16	K/1416/Jahr(Year)	32,00	M/1416/00	32,00	N/1416/00	32,00	R/1416/Zeichen(Symbol)	37,00

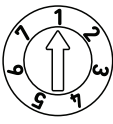
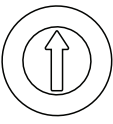
Typ Type	T		WT		Z	
						
Anzeige Indicator	Tage 1 – 31 <i>Days 1 – 31</i>		Wochentage 1 – 7 <i>Weekdays 1 – 7</i>		ohne Kennzeichnung <i>without markings</i>	
D	Bestell-Nr. Order no.	Euro	Bestell-Nr. Order no.	Euro	Bestell-Nr. Order no.	Euro
2,6	—	—	—	30,00	Z/1402,6/00	22,00
2,8	—	—	WT/1402,8/00	30,00	Z/1402,8/00	22,00
3	—	—	WT/1403/00	30,00	Z/1403/00	22,00
3,5	T/1403,5/00	30,00	WT/1403,5/00	30,00	Z/1403,5/00	22,00
4	T/1404/00	30,00	WT/1404/00	30,00	Z/1404/00	22,00
5	T/1405/00	27,00	WT/1405/00	27,00	Z/1405/00	18,50
6	T/1406/00	27,00	WT/1406/00	27,00	Z/1406/00	18,50
8	T/1408/00	27,00	WT/1408/00	27,00	Z/1408/00	18,50
10	T/1410/00	27,00	WT/1410/00	27,00	Z/1410/00	18,50
12	T/1412/00	32,00	WT/1412/00	32,00	Z/1412/00	25,00
16	T/1416/00	32,00	WT/1416/00	32,00	Z/1416/00	25,00

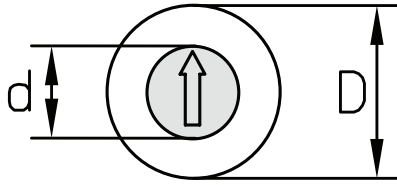

! Stelleinsätze werden auf Wunsch mit Druckfeder geliefert!
 Adjustable insert will be delivered with compression spring on request!

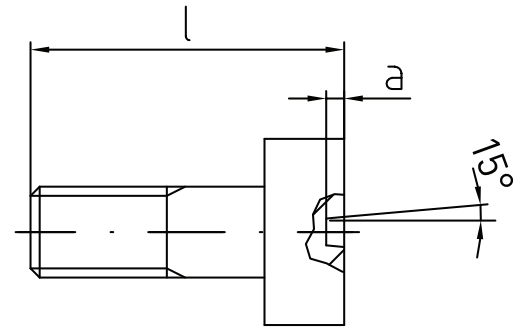

Maßstabelle in mm Dimension table in mm												
D	2,6	2,8	3	3,5	4	5	6	8	10	12	16	mm
d	1,4	1,4	1,5	1,8	2,1	3,1	3,1	4,4	5,2	6,2	8,2	mm
l	3,9	3,9	3,9	4,8	4,8	7,8	7,8	9,8	11,8	13,8	13,8	mm
a	0,2	0,2	0,2	0,2	0,3	0,4	0,4	0,4	0,4	0,6	0,6	mm

Werkstoff:
 1.4034, gehärtet HRC 56 ± 2 rostfrei

Material:
 1.4034, hardened HRC 56 ± 2 stainless

Stelleinsätze für DATI 1400 Adjustable inserts for DATI 1400

Typ Type	F		G		O	
Anzeige Indicator	Stelleinsatz mit Pfeil + Jahr <i>Adjustable inserts with arrow + year</i>		Stelleinsatz mit Pfeil ohne Jahr <i>Adjustable inserts with an arrow without year</i>		Stelleinsatz nach Kundenwunsch mit Zahlen und / oder Buchstaben <i>Adjustable inserts according to customer preference with numbers and / or letters</i>	
D	Bestell-Nr. Order no.	Euro	Bestell-Nr. Order no.	Euro	Bestell-Nr. Order no.	Euro
2,6	F/1402,6/Jahr(Year)	8,50	G/1402,6/00	8,50	O/1402,6/Zeichen(Symbol)	11,00
2,8	F/1402,8/Jahr(Year)	8,50	G/1402,8/00	8,50	O/1402,8/Zeichen(Symbol)	11,00
3	F/1403/Jahr(Year)	8,50	G/1403/00	8,50	O/1403/Zeichen(Symbol)	11,00
3,5	F/1403,5/Jahr(Year)	8,50	G/1403,5/00	8,50	O/1403,5/Zeichen(Symbol)	11,00
4	F/1404/Jahr(Year)	8,50	G/1404/00	8,50	O/1404/Zeichen(Symbol)	11,00
5	F/1405/Jahr(Year)	8,50	G/1405/00	8,50	O/1405/Zeichen(Symbol)	11,00
6	F/1406/Jahr(Year)	8,50	G/1406/00	8,50	O/1406/Zeichen(Symbol)	11,00
8	F/1408/Jahr(Year)	8,50	G/1408/00	8,50	O/1408/Zeichen(Symbol)	11,00
10	F/1410/Jahr(Year)	8,50	G/1410/00	8,50	O/1410/Zeichen(Symbol)	11,00
12	F/1412/Jahr(Year)	9,50	G/1412/00	9,50	O/1412/Zeichen(Symbol)	14,00
16	F/1416/Jahr(Year)	9,50	G/1316/00	9,50	O/1416/Zeichen(Symbol)	14,00

